



UNIDRIVE M ACCESSORIES

Operator Interfaces, Interconnect Components,
and Hardware/Power Options

Control Techniques™

EMERSON[™]
Industrial Automation

Contents

Control Accessories	
Operator Interfaces	3
Interconnect Components	6
Motion Synchronization Accessories	10
Logic and I/O Power Supplies	11
Power Accessories	
Line and Load Reactors.....	12
Isolation Transformers.....	19
Drive EMC Filters.....	20
Dynamic Braking Resistors	22
Hardware Options.....	26

In addition to the options and accessories detailed in this brochure, Emerson can provide a wide range of drive system peripherals through its One Source program. Products offered include AC Motors, DC Motors, Servo Motors, Actuators and Reducers. These world class products are available when purchasing a matched Emerson drive.

To view the latest offering please visit our One Source Partner pages on www.controltechniques.com.



Operator Interfaces

CTVue — Graphical Human Machine Interface

Emerson offers a complete range of HMI (Human Machine Interface) display panels. CTVue Configurator software is FREE and makes programming these HMIs quick and intuitive. The CTVue Configurator software includes built-in communication drivers and predefined drive parameters to speed integration with all Control Techniques drive lines. The broad hardware offering also ensures there is a CTVue HMI that balances price and functionality.

The 4.3-inch CTVue 304KE is designed for applications where available mounting space is at a premium. The smallest touchscreen in the CTVue family, just over 5 inches wide and 4 inches tall, the 304KE boasts a bright TFT (thin film transistor) display with full 32K-color support.

For small and economical displays, the 303L and 303M offer a 3.2-inch monochrome graphical LCD display. The 303L is the low-cost choice with one RS485 port. The 303M is full featured with one Ethernet, one RS485, two RS232, and one Compact Flash port.

For medium-size displays, the 306M/A and 308A graphical touchscreens provide larger screens for enhanced display of graphics. The 306 and 308 versions include Ethernet, one RS485, two RS232, and one Compact Flash port and are available with color or monochrome graphical display.

For large displays, the 310C and 315C graphical color touchscreens provide the most graphical display area while offering all the connectivity and features of the 306 and 308 series plus a USB host port and option for an additional Ethernet port. Super-bright NEMA 4X outdoor versions are also available - 303S, 306MS and 310S.

All of the CTVue HMIs, except the CTVue 304KE, have a Compact Flash port which allows for storage and transfer of data from a variety of external data sources using a standard Compact Flash card (order separately).



Key Features

- Integrated Control Techniques drivers
- Remote web and FTP access (except 304KE)
- Powerful protocol converter
- USB programming port (except 304KE)
- Alarming and data logging
- Bright TFT color display offerings
- Free, simple-to-use, programming software
- Flexible Compact Flash slot (except 304KE)
- Security user levels/passwords
- Available front faceplate customization
- For use in hazardous locations
- 24V operation

CTVUE-304KE



- 4.3-inch, 480 x 272, Graphic Touch, TFT, 32K-color display
- Ethernet, RS485 and RS232 port
- 128MB onboard flash memory

CTVUE-303L/M/S



- 3.2-inch, 128 x 64, LCD, monochrome display
- Ethernet (M), RS485 (L), outdoor version available (S)
- 8 x customizable function keys
- Compact Flash slot (M)(S)
- 4MB non-volatile flash memory
- USB host port

CTVUE-306M/A/MS



- 5.7-inch, 320 x 240, Graphic Touch display
 - (M) LCD, monochrome
 - (A) TFT, 256-color
 - (MS) LCD, monochrome (with UV protection for outdoors)
- Ethernet, RS485 and RS232 port
- Compact Flash slot
- 4/8MB non-volatile flash memory
- Four programmable soft keys
- USB host port

CTVUE-308A/E



- 8.4-inch, 640x480, Graphic Touch, TFT, 32K-color display
- Ethernet, RS485 and RS232 port
- Compact Flash slot
- 32MB non-volatile flash memory
- Six programmable soft keys
- USB host port

Operator Interfaces

CTVUE-310C / E / R / RE / S / SE



- 10.4-inch, 640 x 480 (C, E, S, SE), 800 x 600 (R, RE), Graphic Color Touch, TFT, 32K-color display
- Ethernet, RS232, RS485 port
- Compact Flash slot
- 32MB non-volatile flash memory
- Outdoor version available
- USB host port

CTVUE-315C/E

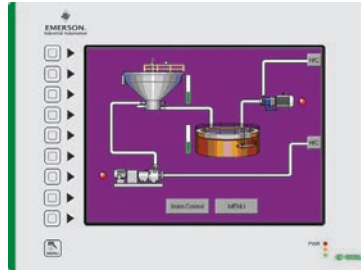

- 15-inch, 1024 x 768, Graphic Color Touch, TFT, 32K-color display
- Ethernet, RS485, and RS232 port
- Compact Flash slot
- 64MB non-volatile flash memory
- USB host port

When mounted using the supplied gasket, all panels have a rating of IP66 / NEMA 4X.

Order Code	Description	Dims. (in) HxWxD
CTVUE-304KE	4.3", 480 x 272, TFT, 32K-color touchscreen - with RS232, RS485, Ethernet	4 x 5 x 1.5
CTVUE-303L	3.2", 128 x 64, LCD, monochrome display - with 1 x RS485	5.9 x 7.5 x 2.1
CTVUE-303M	3.2", 128 x 64, LCD, monochrome display - with Ethernet, RS485, RS232, Compact Flash	
CTVUE-303S	3.2", 128 x 64, LCD, monochrome display - with Ethernet, RS485, RS232, Compact Flash (with UV protection for outdoor use)	
CTVUE-306M	5.7", 320 x 240, LCD, monochrome, touchscreen - with Ethernet, RS485, RS232	7.1 x 8.8 x 2.3
CTVUE-306A	5.7", 320 x 240, TFT, 256-color touchscreen - with Ethernet, RS485, RS232	
CTVUE-306MS	5.7", 320 x 240, LCD, monochrome, touchscreen - with Ethernet, RS485, RS232 (with UV protection for outdoor use)	9.5 x 12.9 x 2.2
CTVUE-308A	8.4", 640 x 480, TFT, 32K-color touchscreen - with (1) Ethernet, isolated comms RS485, RS232	
CTVUE-308E	8.4", 640 x 480, TFT, 32K-color touchscreen - with (2) Ethernet, isolated comms RS485, RS232	
CTVUE-310C	10.4", 640 x 480, TFT, 32k-color touchscreen - with (1) Ethernet, isolated comms RS485, RS232	
CTVUE-310S	10.4", 640 x 480, TFT, 32k-color touchscreen - with (1) Ethernet, isolated comms RS485, RS232 (with UV protection)	
CTVUE-310E	10.4", 640 x 480, TFT, 32k-color touchscreen - with (2) Ethernet, isolated comms RS485, RS232	
CTVUE-310R	10.4", 800 x 600, TFT, 32k-color touchscreen - with (1) Ethernet, isolated comms RS485, RS232	13 x 16 x 2.8
CTVUE-310RE	10.4", 800 x 600, TFT, 32k-color touchscreen - with (2) Ethernet, isolated comms RS485, RS232	
CTVUE-310SE	10.4", 640 x 480, TFT, 32k-color touchscreen - with (2) Ethernet, isolated comms RS485, RS232 (with UV protection)	
CTVUE-315C	15", 1024 x 768, TFT, 32k-color touchscreen - with (1) Ethernet, RS485, RS232	13 x 16 x 2.8
CTVUE-315E	15", 1024 x 768, TFT, 32k-color touchscreen - with (2) Ethernet, RS485, RS232	
CTVUE-CF1000	1 GB industrial Compact Flash memory	
CTVUE-CF2000	2 GB Industrial Compact Flash memory	
CTVUE-CONFIG-CD	FREE programming software CD	
CTVUE-USB	USB Programming cable PC to CTVue	
CTVUE-EP-485-xxx*	RS485 cable; RJ45 to RJ45	
SP-LCD-485-xxx*	RS485 cable for multidrop; RJ45 to RJ45	
CT-USB-CABLE	Modbus (RS485) to USB conversion	
CTVUE-RS00	RS232 / RS485 communications option card	
CTVUE-CN00	CANOpen communications option card	
CTVUE-PBDP	Profibus-DP communications option card	
CTVUE-DN00	DeviceNet communications option card	
CTVUE-PRO-4K	Serial Port cable for programming CTVUE-304KE	
CTVUE-ADK-485	DB9-pin connector to RJ45 adaptor (for use with CTVUE-EP-485 cables)	
CTVUE-USB-4K	USB to RS232 converter cable includes CTVUE-PRO-4K cable	

* Standard cable lengths: 5, 15, 25ft (-005) (-015) (-025)

CTVue Connectivity and Functionality

The CTVue touchscreens are easy to set up and connect to your application.

Connection to the Serial Port

The operator interface is connected directly to the RJ45 connection on the serial port of the drive. RS485 is a multi-drop protocol and may be connected to multiple drives if required.

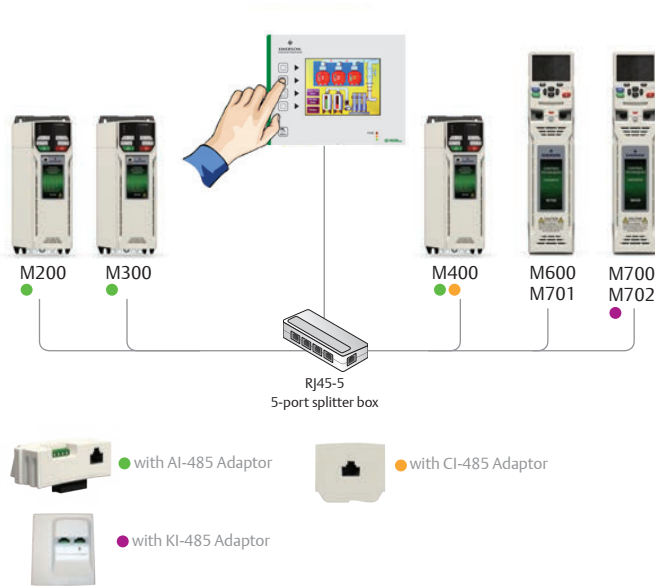

Connecting via Ethernet

The Unidrive M700, Unidrive M702, SI-Ethernet, and MCI 210 Option Modules allow the operator interface to be connected to the drive using Modbus TCP/IP.

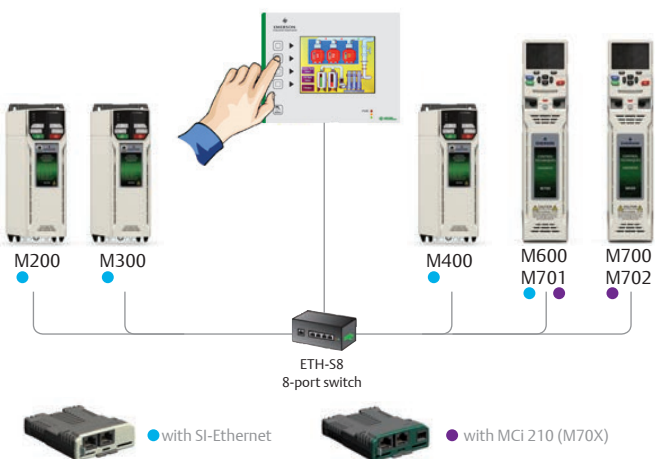

CT Vue Specifications

Power Input	24Vdc
Temperature	32 to 122 °F (0 to 50 °C)
Environmental	IP66 / NEMA 4X, for use in hazardous locations:*
	Class I, Division 2, Groups A,B,C and D
	Class II, Division 2, Groups F and G
Operating Humidity	80% relative maximum from 32 to 122 °F (0 to 50 °C)

* see website for individual data sheets



Interconnect Components

Operator Interface Single-drop Cables

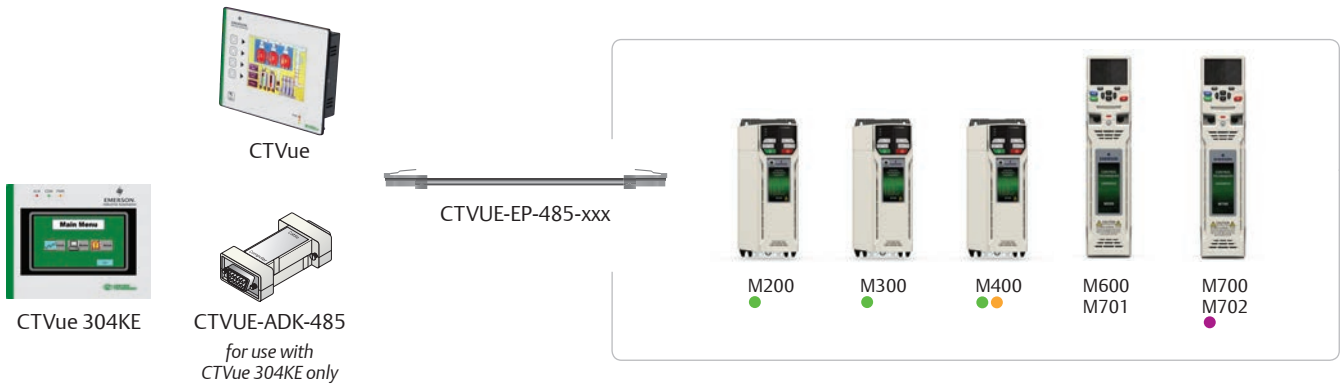

CTVUE-EP-485-xxx
RS485 cable; RJ45 to RJ45

SP-LCD-485-xxx
RS485 cable with RJ45 connector on both ends for LCD Keypad and Unidrive M

CTVUE-ADK-485
RS485 DB9pin to RJ45 adaptor is used with the CTVUE-304KE and appropriate drive RS485 cable

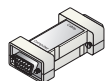

xxx = length in feet

Operator Interface Multi-drop Cables

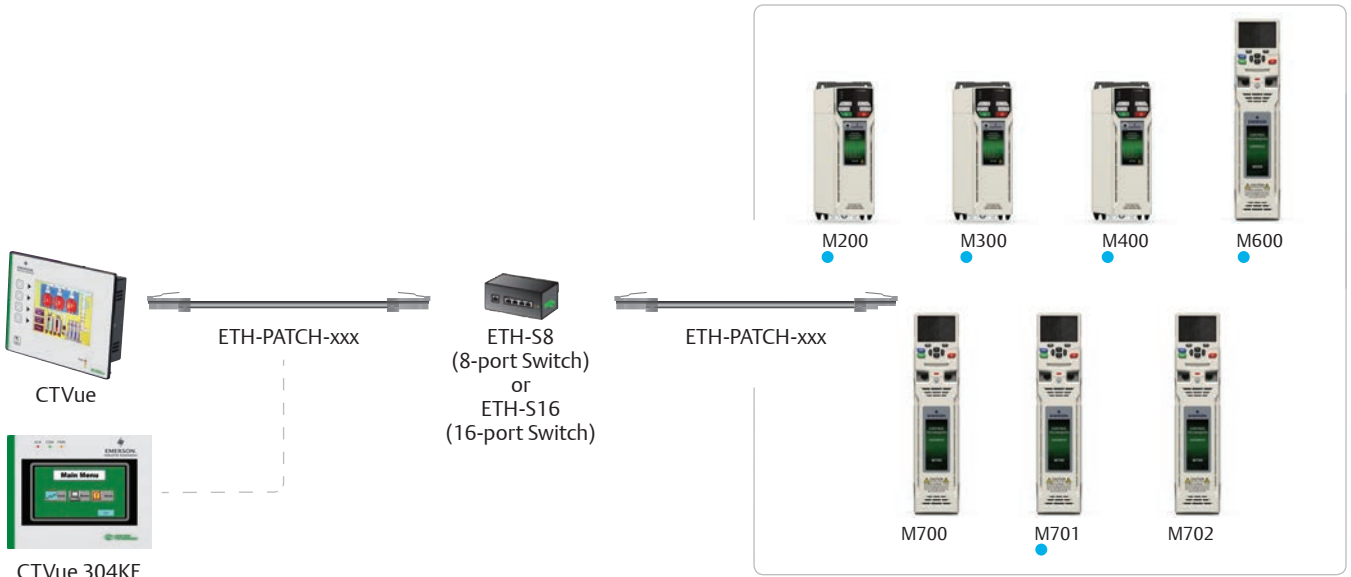
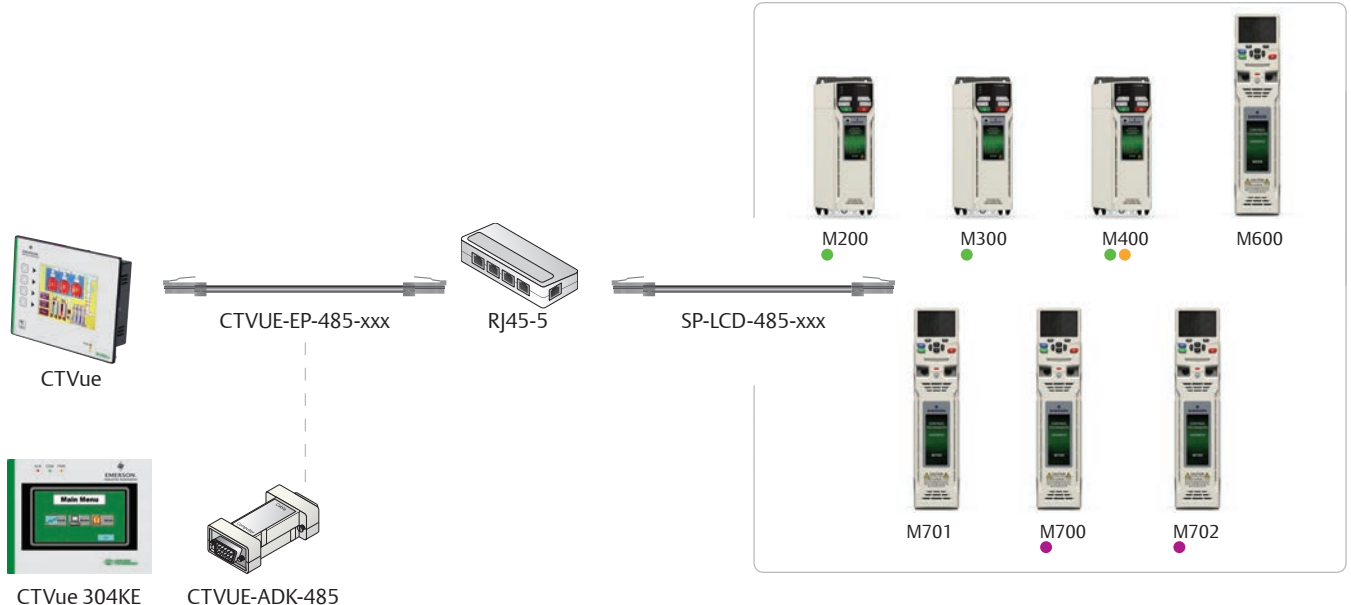

CTVUE-EP-485-xxx
RS485 cable; RJ45 to RJ45

SP-LCD-485-xxx
RS485 cable for multidrop; RJ45 connector on both ends

ETH-PATCH-xxx
RJ45 ethernet patch cable; wires dressed at both ends

xxx = length in feet

Interconnect Components

Operator Interface Software Cables

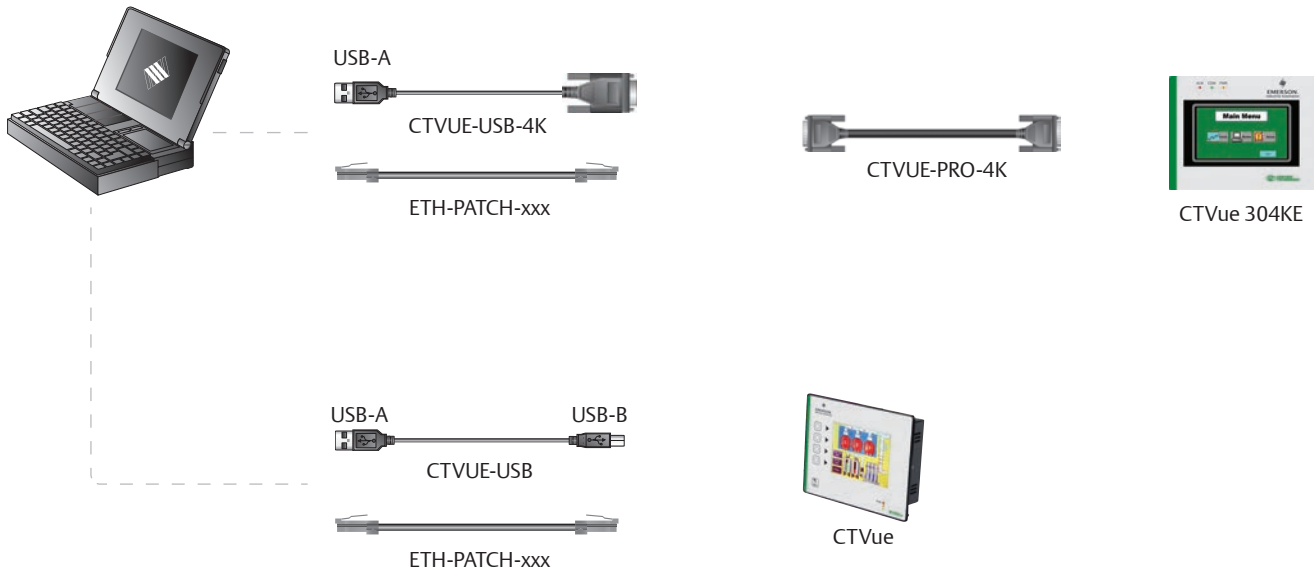

CT-USB-CABLE

Connects the Modbus port on the drive (RS485) directly to the USB port on your PC; USB to RS485 conversion



CTVUE-USB

CTVue USB programming cable: USB Connectors on both ends; USB-A on drive side and USB-B on panel side



SP-LCD-485-xxx

RS485 cable for multidrop: RJ45 connector on both ends



xxx = length in feet

RJ45-5

RJ45 Splitter; accepts one RJ45 connector of input and 4 RJ45 connectors for output

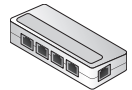

CTVUE-USB-4K

USB to RS232 converter for programming CTVUE-304KE; this order code includes CTVUE-PRO-4K cable



CTVUE-PRO-4K

Serial port cable for convenient connection to CTVUE-304KE to PC.



Software Interface Single or Multi-drop Cables

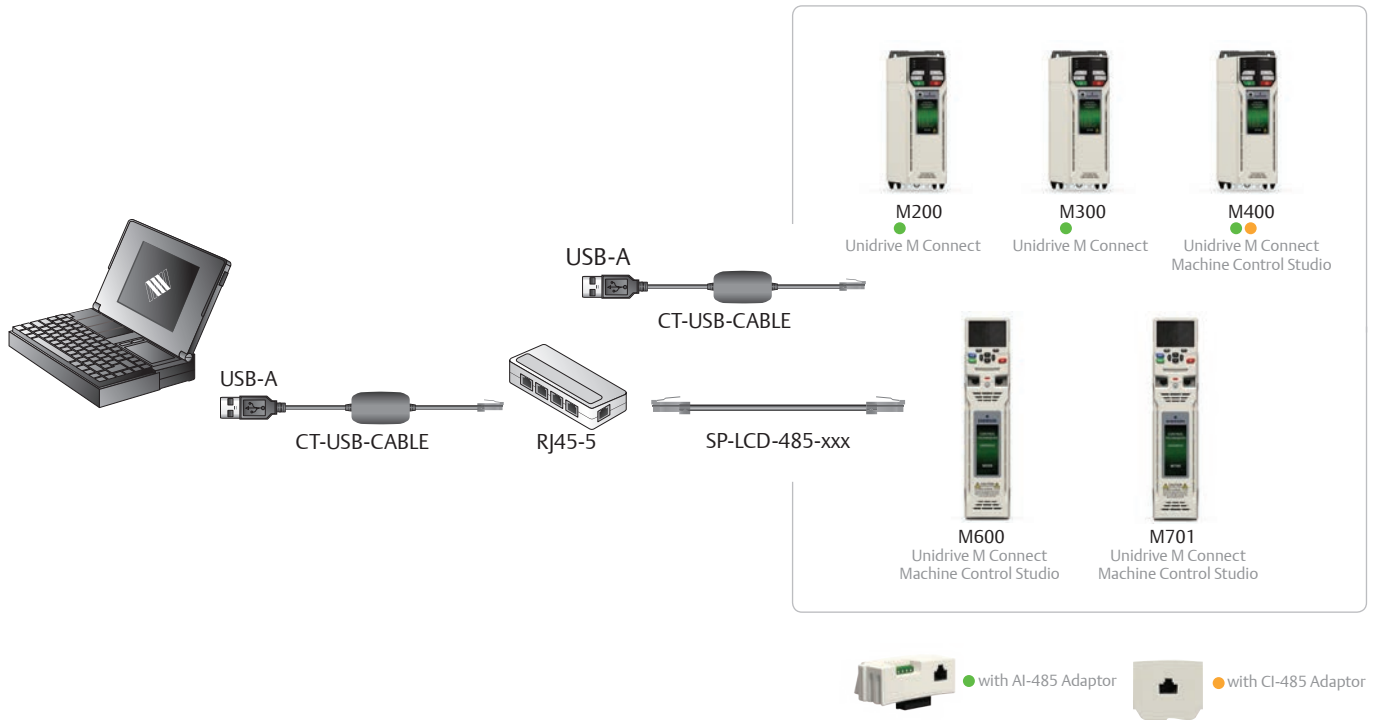

Software Interface with Ethernet

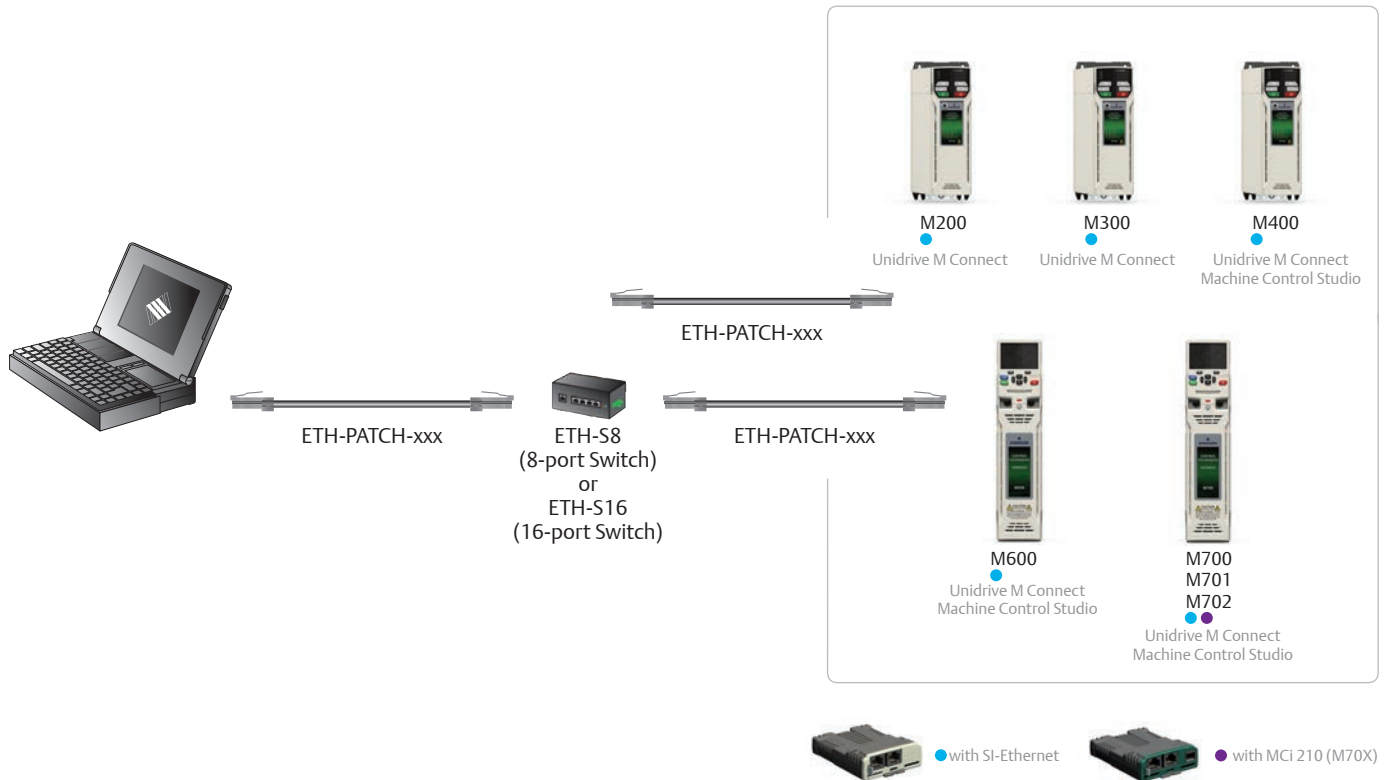

Motion Synchronization Components

Emerson's hardware provides easy configuration of motion synchronization. Pre-configured cables are available for connection from a master synchronization encoder to drive connections. Unidrive M700 increases flexibility and reduces system costs through simultaneously connecting up to three high-performance encoder channels as standard. The drive can interface with a feedback encoder, reference encoder and provide one simulated encoder output.

- Two universal encoder input channels
 - Support for standard incremental and SinCos encoders, including those with absolute signals.
 - Support for communications based on encoders with up to 4Mb rate and line compensations to support long cable lengths up to 100m. Includes EnDat 2.2, Hiperface, and SSI.

Using the preconfigured cables, 1.5-axis synchronization is easily achieved.

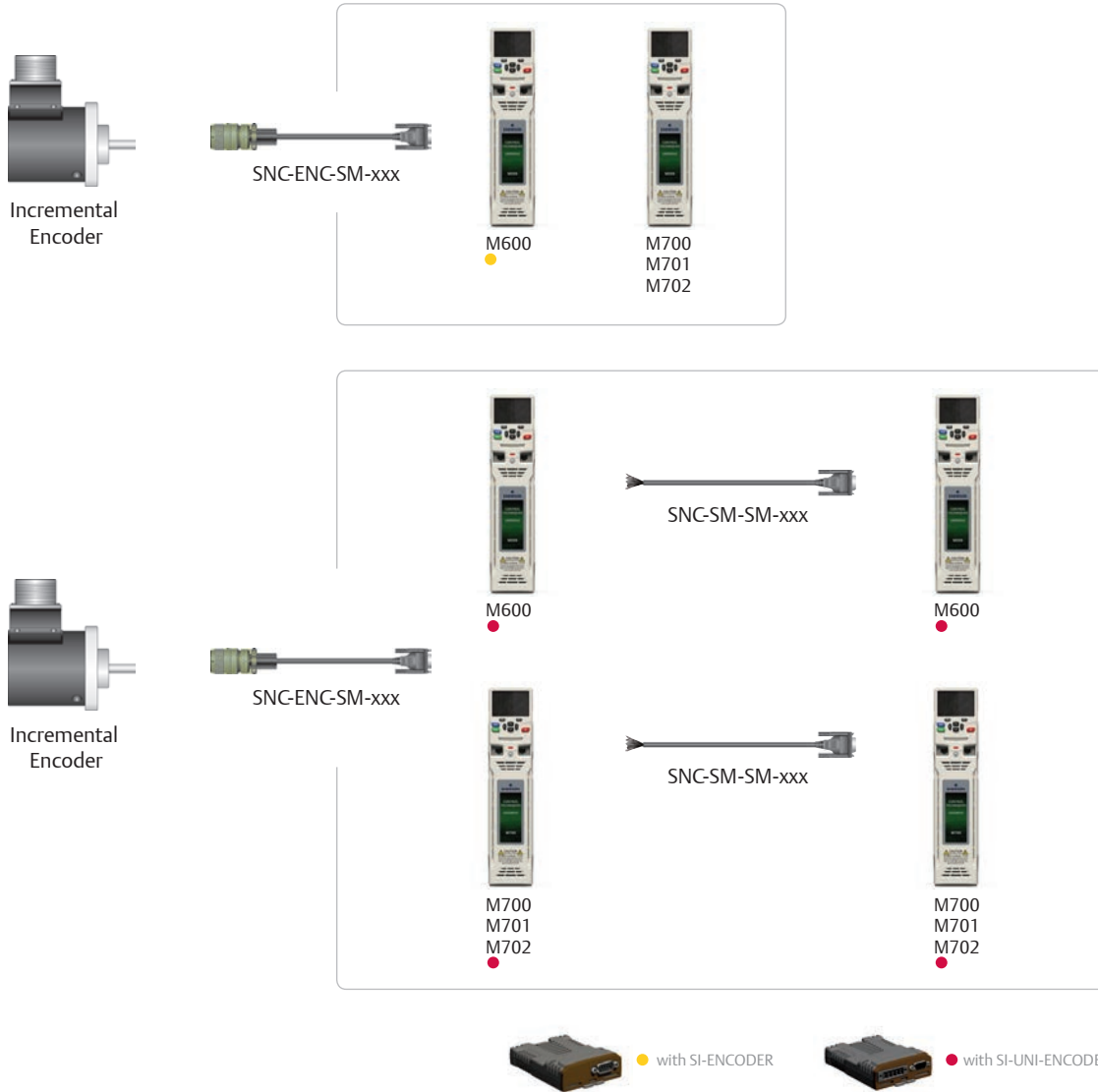

SNC-ENC-SM -010, -025, -050
 Sync cable to SI-Universal Encoder, Encoder connector to D15P connector
 SCSLD to SI-Universal Encoder or SI-Encoder

SNC-SM-SM-xxx
 SI-Universal Encoder output to SI-Universal Encoder. DB15 connector on one end, flying leads on the other

xxx = length in feet

Encoder Order Codes

Description	Side Connection Order Code	End Connection Order Code
Synchronization Encoder 3000 Line (12000 ppr Quadrature)	SCSLD-4R	SCSLD-4
Synchronization Encoder 2500 Line (10000 ppr Quadrature)	SCSLD-3R	SCSLD-3
Synchronization Encoder 1000 Line (4000 ppr Quadrature)	SCSLD-2R	SCSLD-2

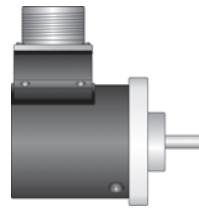

Side Connector

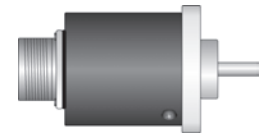

End Connector

Encoder Breakout Boards

SM-ETC

Encoder feedback connector breakout board (DB15)

Encoder Specifications

Supply Voltage	+5Vdc
Current	Line drives with ZR=+5Vdc @ 5mA
Frequency	Up to 200kHz
Outputs	Analog - differential peak-to-peak amplitude of 2.5Vdc
Operating Temp.	32 to 158 °F (0 to 70 °C)

* see website for individual data sheets

Logic and I/O Power Supplies

MLP-002-00

2.1 Amp, +24 Vdc, universal input
90 to 264Vac

MLP-005-00

5 Amp, +24Vdc, universal input
90 to 264Vac

MLP-010-00

10 Amp, +24Vdc, universal input 90 to 264Vac

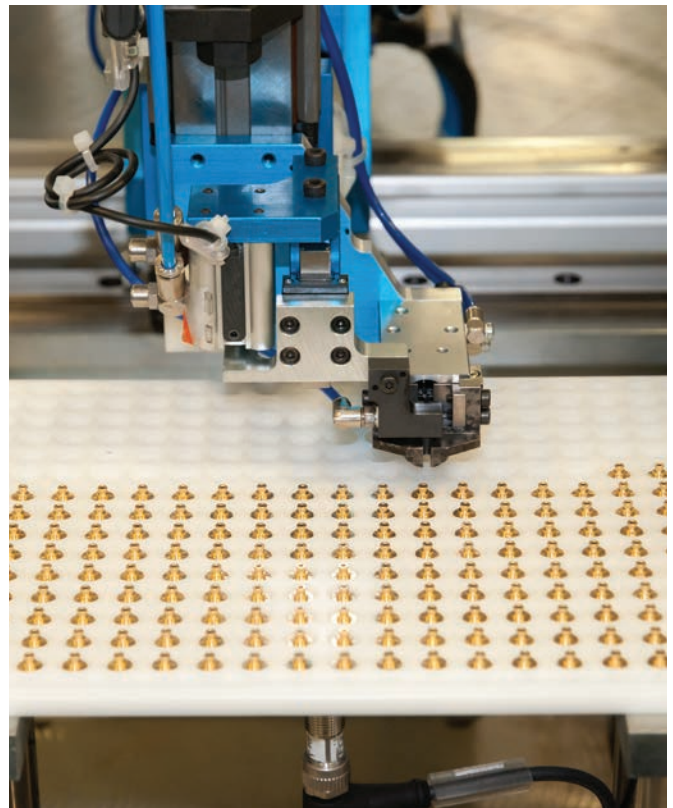
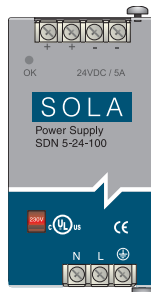

Line and Load Reactors

Line and Load Reactors

Line reactors (sometimes called “line chokes”) are a common power accessory for electronic variable speed drives. These components add an extra margin of protection for AC drives from supply transients.

Line reactors are strongly recommended for installation with AC drives that do not have built-in inductors. Refer to the built-in inductor columns in the following tables.

Load reactors are used on the output of AC drives to reduce the effects of high motor wiring capacitance and to “soften” the dV/dt (rate of change of voltage) applied to the motor windings.

Reactors in AC drive applications:

- Help reduce harmonic distortion of the input line current
- Improve input line current balance
- Reduce nuisance drive over-voltage trips caused by transient voltage spikes and power line notches
- Protect input rectifiers from in-rush current caused by sudden power line surges and sags
- Extend the life of the DC bus capacitor bank by reducing the internal heating caused by ripple current
- Protect motor windings from long lead effects when used on the drive output

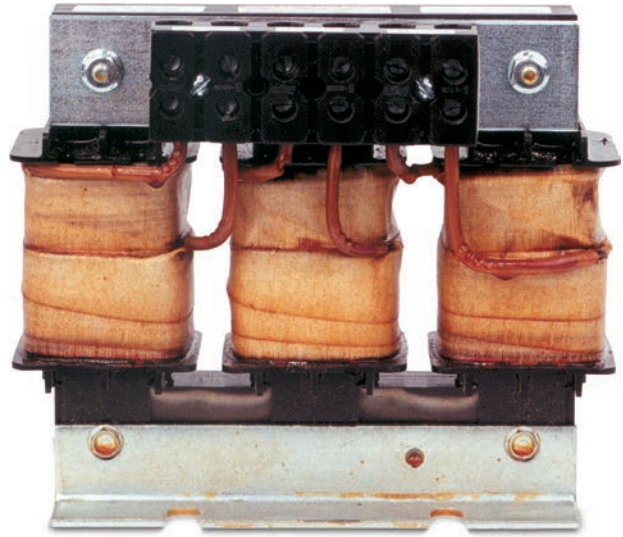

Line and Load Reactor Specifications	
Voltage	690Vac maximum
Ambient Temperature	104 °F (40 °C)
Overload	200% for 10 seconds 150% for 1 minute
Approvals	CE UL508 CSA C22.2

Order Code

xx - x - xxxxA - x

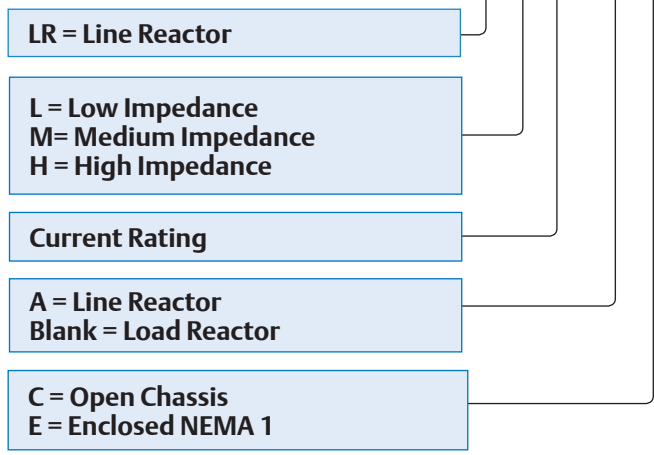

Input Line Reactors - 115 Vac & 230 Vac

Line Reactor 3%

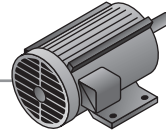
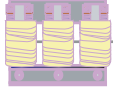

115 Vac, Single Phase 50/60 Hz							
Drive	Built-In Inductor	Amps	Inductance (µH)	Watts Loss	Chassis Mount		
					Order Code	Dims. (in) H x W x D	Weight (lbs)
Maaa-01100017	No	21	530	38.3	LRL0021A-C	5.3 x 4.4 x 3.3	4.2
Maaa-01100024	No	28	390	48.2	LRL0028A-C	5.3 x 4.4 x 3.5	5.1
Maaa-02100042	No	55	270	67	LRL0055A-C	6 x 7.2 x 4	18
Maaa-02100056	No	65	190	87	LRL0065A-C	6 x 7.2 x 4	18

230 Vac, Single Phase 50/60 Hz							
Drive	Built-in Inductor	Amps	Inductance (µH)	Watts Loss	Chassis Mount		
					Order Code	Dims. (in) H x W x D	Weight (lbs)
Maaa-01200017	No	4.8	2300	13.8	LRL004A8-C	3.7 x 4.5 x 1.5	1.7
Maaa-01200024	No	7.6	1500	19.2	LRL007A6-C	3.7 x 4.5 x 1.5	1.8
Maaa-01200033	No	11	1000	26.8	LRL0011A-C	5 x 4.4 x 2.8	2.7
Maaa-01200042	No	11	1000	26.8	LRL0011A-C	5 x 4.4 x 2.8	2.7
Maaa-02200024	No	7.6	1500	19.2	LRL007A6-C	3.7 x 4.5 x 1.5	1.8
Maaa-02200033	No	11	1000	26.8	LRL0011A-C	5 x 4.4 x 2.8	2.7
Maaa-02200042	No	11	1000	26.8	LRL0011A-C	5 x 4.4 x 2.8	2.7
Maaa-02200056	No	21	530	38.3	LRL0021A-C	5.3 x 4.4 x 3.3	4.2
Maaa-02200075	No	21	530	38.3	LRL0021A-C	5.3 x 4.4 x 3.3	4.2
Maaa-03200100	No	28	390	48.2	LRL0028A-C	5.3 x 4.4 x 3.5	5.1
Maaa-04200133	Yes	28	390	48.2	LRL0028A-C	5.3 x 4.4 x 3.5	5.1

230 Vac, 3 Phase 50/60 Hz										
Drive	Built-in Inductor	Amps	Inductance (µH)	Watts Loss	Chassis Mount			NEMA 1 Enclosed		
					Order Code	Dims. (in) H x W x D	Weight (lbs)	Order Code	Dims. (in) H x W x D	Weight (lbs)
Maaa-02200024	No	4.8	2300	13.8	LRL004A8-C	3.7 x 4.5 x 1.5	1.7	LRL004A8-E	8 x 8 x 6	8.7
Maaa-02200033	No	7.6	1500	19.2	LRL007A6-C	3.7 x 4.5 x 1.5	1.8	LRL007A6-E	8 x 8 x 6	8.8
Maaa-02200042	No	7.6	1500	19.2	LRL007A6-C	3.7 x 4.5 x 1.5	1.8	LRL007A6-E	8 x 8 x 6	8.8
Maaa-02200056	No	14	790	32.7	LRL0014A-C	5.3 x 4.4 x 2.8	2.8	LRL0014A-E	8 x 8 x 6	9.8
Maaa-02200075	No	14	790	32.7	LRL0014A-C	5.3 x 4.4 x 2.8	2.8	LRL0014A-E	8 x 8 x 6	9.8
Maaa-03200100	No	21	530	38.3	LRL0021A-C	5.3 x 4.4 x 3.3	4.2	LRL0021A-E	13.3 x 13.2 x 13.1	22.2
Maaa-04200133	Yes	21	530	38.3	LRL0021A-C	5.3 x 4.4 x 3.3	4.2	LRL0021A-E	13.3 x 13.2 x 13.1	22.2
Maaa-04200176	Yes	28	390	48.2	LRL0028A-C	5.3 x 4.4 x 3.5	5.1	LRL0028A-E	13.3 x 13.2 x 13.1	23.1
Mbbb-03200050	No	11	1000	26.8	LRL0011A-C	5 x 4.4 x 2.8	2.7	LRL0011A-E	8 x 8 x 6	9.7
Mbbb-03200066	No	14	790	32.7	LRL0014A-C	5.3 x 4.4 x 2.8	2.8	LRL0014A-E	8 x 8 x 6	9.8
Mbbb-03200080	No	21	530	38.3	LRL0021A-C	5.3 x 4.4 x 3.3	4.2	LRL0021A-E	13.3 x 13.2 x 13.1	22.2
Mbbb-03200106	No	21	530	38.3	LRL0021A-C	5.3 x 4.4 x 3.3	4.2	LRL0021A-E	13.3 x 13.2 x 13.1	22.2
Mbbb-04200137	Yes	21	530	38.3	LRL0021A-C	5.3 x 4.4 x 3.3	4.2	LRL0021A-E	13.3 x 13.2 x 13.1	22.2
Mbbb-04200185	Yes	28	390	48.2	LRL0028A-C	5.3 x 4.4 x 3.5	5.1	LRL0028A-E	13.3 x 13.2 x 13.1	23.1
Mddd-09201760	No	250	50	275	LRL0250A-C	7.5 x 9.5 x 7.5	35	LRL0250A-E	24 x 16.9 x 18.4	62
Mddd-09202190	No	322	50	300	LRL0322A-C	7.5 x 9.3 x 9	57	LRL0322A-E	24 x 16.9 x 18.4	84
Mbbb-10202830	No	414	33	333	LRL0414A-C	8.8 x 9 x 9.5	78	LRL0414A-E	47 x 26.5 x 24.9	222
Mbbb-10203000	No	414	33	333	LRL0414A-C	8.8 x 9 x 9.5	78	LRL0414A-E	47 x 26.5 x 24.9	222
Mccc-05200250	Yes	35	400	49	LRL0035A-C	6 x 6 x 3.5	10	LRL0035A-E	13.3 x 13.2 x 13.1	28
Mccc-06200330	Yes	55	270	67	LRL0055A-C	6 x 7.2 x 4	18	LRL0055A-E	13.3 x 13.2 x 13.1	36
Mccc-06200440	Yes	65	190	87	LRL0065A-C	6 x 7.2 x 4	18	LRL0065A-E	13.3 x 13.2 x 13.1	36
Mddd-07200610	Yes	83	170	119	LRL0083A-C	6 x 7.2 x 4.3	19	LRL0083A-E	13.3 x 13.2 x 13.1	37
Mddd-07200750	Yes	104	120	94	LRL0104A-C	6 x 7.2 x 6.5	22	LRL0104A-E	13.3 x 13.2 x 13.1	40
Mddd-07200830	Yes	130	95	132	LRL0130A-C	7.5 x 9.3 x 6.8	26	LRL0130A-E	13.3 x 13.2 x 13.1	44
Mddd-08201160	Yes	160	80	110	LRL0160A-C	7.5 x 9.3 x 6.8	34	LRL0160A-E	13.3 x 13.2 x 13.1	52
Mddd-08201320	Yes	200	60	159	LRL0200A-C	7.5 x 9.3 x 7.0	34	LRL0200A-E	24 x 16.9 x 18.4	61

aaa = Unidrive M100, M101, M200, M201, M300 & M400

Consult factory for different percentage impedance and NEMA 3R outdoor enclosure options.

bbb = Unidrive M600, M700, M701, M702, HS70, HS71, HS72

ccc = Unidrive M200, M201, M300, M400, M600, M700, M701, M702, HS70, HS71, HS72

ddd = Unidrive M400, M600, M700, M701, M702, HS70, HS71, HS72

Line reactors are recommended for AC drives that do not include a built-in inductor.

For drive modules that include DC or AC inductors built in, the line reactors above provide additional impedance.

Output Load Reactors - 230 Vac



Load Reactor 3%

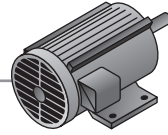
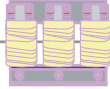

230 Vac 3 Phase									
Drive	Amps	Inductance (μH)	Watts Loss	Chassis Mount			NEMA 1 Enclosed		
				Order Code	Dims. (in) H x W x D	Weight (lbs)	Order Code	Dims. (in) H x W x D	Weight (lbs)
Maaa-01100017	3.4	3200	12.3	LRL003A4-C	3.7 x 4.5 x 1.5	1.6	LRL003A4-E	8 x 8 x 6	8.6
Maaa-01100024	3.4	3200	12.3	LRL003A4-C	3.7 x 4.5 x 1.5	1.6	LRL003A4-E	8 x 8 x 6	8.6
Maaa-02100042	7.6	1500	19.2	LRL007A6-C	3.7 x 4.5 x 1.5	1.8	LRL007A6-E	8 x 8 x 6	8.8
Maaa-02100056	7.6	1500	19.2	LRL007A6-C	3.7 x 4.5 x 1.5	1.8	LRL007A6-E	8 x 8 x 6	8.8
Maaa-01200017	3.4	3200	12.3	LRL003A4-C	3.7 x 4.5 x 1.5	1.6	LRL003A4-E	8 x 8 x 6	8.6
Maaa-01200024	3.4	3200	12.3	LRL003A4-C	3.7 x 4.5 x 1.5	1.6	LRL003A4-E	8 x 8 x 6	8.6
Maaa-01200033	4.8	2300	13.8	LRL004A8-C	3.7 x 4.5 x 1.5	1.7	LRL004A8-E	8 x 8 x 6	8.7
Maaa-01200042	7.6	1500	19.2	LRL007A6-C	3.7 x 4.5 x 1.5	1.8	LRL007A6-E	8 x 8 x 6	8.8
Maaa-02200024	3.4	3200	12.3	LRL003A4-C	3.7 x 4.5 x 1.5	1.6	LRL003A4-E	8 x 8 x 6	8.6
Maaa-02200033	4.8	2300	13.8	LRL004A8-C	3.7 x 4.5 x 1.5	1.7	LRL004A8-E	8 x 8 x 6	8.7
Maaa-02200042	7.6	1500	19.2	LRL007A6-C	3.7 x 4.5 x 1.5	1.8	LRL007A6-E	8 x 8 x 6	8.8
Maaa-02200056	7.6	1500	19.2	LRL007A6-C	3.7 x 4.5 x 1.5	1.8	LRL007A6-E	8 x 8 x 6	8.8
Maaa-02200075	11	1000	26.8	LRL0011A-C	5 x 4.4 x 2.8	2.7	LRL0011A-E	8 x 8 x 6	9.7
Maaa-03200100	14	790	32.7	LRL0014A-C	5.3 x 4.4 x 2.8	2.8	LRL0014A-E	8 x 8 x 6	9.8
Maaa-04200133	21	530	38.3	LRL0021A-C	5.3 x 4.4 x 3.3	4.2	LRL0021A-E	13.3 x 13.2 x 13.1	22.2
Maaa-04200176	28	390	48.2	LRL0028A-C	5.3 x 4.4 x 3.5	5.1	LRL0028A-E	13.3 x 13.2 x 13.1	23.1
Mbbb-03200050	11	1000	26.8	LRL0011A-C	5 x 4.4 x 2.8	2.7	LRL0011A-E	8 x 8 x 6	9.7
Mbbb-03200066	11	1000	26.8	LRL0011A-C	5 x 4.4 x 2.8	2.7	LRL0011A-E	8 x 8 x 6	9.7
Mbbb-03200080	14	790	32.7	LRL0014A-C	5.3 x 4.4 x 2.8	2.8	LRL0014A-E	8 x 8 x 6	9.8
Mbbb-03200106	21	530	38.3	LRL0021A-C	5.3 x 4.4 x 3.3	4.2	LRL0021A-E	13.3 x 13.2 x 13.1	22.2
Mbbb-04200137	28	390	48.2	LRL0028A-C	5.3 x 4.4 x 3.5	5.1	LRL0028A-E	13.3 x 13.2 x 13.1	23.1
Mbbb-04200185	35	400	49	LRL0035A-C	6 x 6 x 3.5	10	LRL0035A-E	13.3 x 13.2 x 13.1	28
Mddd-09201760	322	50	300	LRL0322A-C	7.5 x 9.3 x 9	57	LRL0322A-E	24 x 16.9 x 18.4	84
Mddd-09202190	414	33	333	LRL0414A-C	8.8 x 9 x 9.5	78	LRL0414A-E	47 x 26.5 x 24.9	222
Mbbb-10202830	515	25	314	LRL0515A-C	8.8 x 9 x 9.5	81	LRL0515A-E	47 x 26.5 x 24.9	225
Mbbb-10203000	515	25	314	LRL0515A-C	8.8 x 9 x 9.5	81	LRL0515A-E	47 x 26.5 x 24.9	225
Mccc-05200250	46	300	77	LRL0046A-C	6 x 7.2 x 3.8	13	LRL0046A-E	13.3 x 13.2 x 13.1	31
Mccc-06200330	65	190	87	LRL0065A-C	6 x 7.2 x 4	18	LRL0065A-E	13.3 x 13.2 x 13.1	36
Mccc-06200440	83	170	119	LRL0083A-C	6 x 7.2 x 4.3	19	LRL0083A-E	13.3 x 13.2 x 13.1	37
Mddd-07200610	104	120	94	LRL0104A-C	6 x 7.2 x 6.5	22	LRL0104A-E	13.3 x 13.2 x 13.1	40
Mddd-07200750	130	95	132	LRL0130A-C	7.5 x 9.3 x 6.8	26	LRL0130A-E	13.3 x 13.2 x 13.1	44
Mddd-07200830	160	80	110	LRL0160A-C	7.5 x 9.3 x 6.8	34	LRL0160A-E	13.3 x 13.2 x 13.1	52
Mddd-08201160	200	60	159	LRL0200A-C	7.5 x 9.3 x 7.0	34	LRL0200A-E	24 x 16.9 x 18.4	61
Mddd-08201320	250	50	275	LRL0250A-C	7.5 x 9.5 x 7.5	35	LRL0250A-E	24 x 16.9 x 18.4	62

aaa = Unidrive M100, M101, M200, M201, M300 & M400

bbb = Unidrive M600, M700, M701, M702, HS70, HS71, HS72

ccc = Unidrive M200, M201, M300, M400, M600, M700, M701, M702, HS70, HS71, HS72

ddd = Unidrive M400, M600, M700, M701, M702, HS70, HS71, HS72

Consult factory for different percentage impedance and NEMA 3R outdoor enclosure options.



Input Line Reactors - 460 Vac

Line Reactor 3%

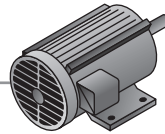
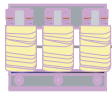

460 Vac, 3 Phase 50/60 Hz										
Drive	Built-In Inductor	Amps	Inductance (µH)	Watts Loss	Chassis Mount			NEMA 1 Enclosed		
					Order Code	Dims. (in) H x W x D	Weight (lbs)	Order Code	Dims. (in) H x W x D	Weight (lbs)
Maaa-02400013	No	3.4	11000	26.5	LRH003A4-C	3.7 x 4.5 x 1.5	1.6	LRH003A4-E	8 x 8.1 x 6.1	8.6
Maaa-02400018	No	3.4	6800	19.6	LRM003A4-C	3.7 x 4.5 x 1.5	1.6	LRM003A4-E	8 x 8 x 6	8.6
Maaa-02400023	No	4.8	7700	37.5	LRH004A8-C	5 x 4.4 x 2.8	2.8	LRH004A8-E	8 x 8.1 x 6.1	8.6
Maaa-02400032	No	7.6	4800	47.8	LRH007A6-C	5 x 4.4 x 3.1	4.1	LRH007A6-E	8 x 8 x 6	11.1
Maaa-02400041	No	7.6	3000	37.2	LRM007A6-C	5 x 4.4 x 2.8	2.8	LRM007A6-E	8 x 8 x 6	9.8
Maaa-03400056	No	11	2100	40.9	LRM0011A-C	5 x 4.4 x 3.1	4.2	LRM0011A-E	8 x 8 x 6	11.2
Maaa-03400073	No	11	2100	40.9	LRM0011A-C	5 x 4.4 x 3.1	4.2	LRM0011A-E	8 x 8 x 6	11.2
Maaa-03400094	No	14	1600	48.2	LRM0014A-C	5 x 4.4 x 3.1	4.3	LRM0014A-E	8 x 8 x 6	11.3
Maaa-04400135	No	14	1600	48.2	LRM0014A-C	5 x 4.4 x 3.1	4.3	LRM0014A-E	8 x 8 x 6	11.3
Maaa-04400170	Yes	21	1100	57.4	LRM0021A-C	6.1 x 6 x 2.6	7.2	LRM0021A-E	13.3 x 13.2 x 13.1	25.2
Mbbb-03400025	No	7.6	4800	47.8	LRH007A6-C	5 x 4.4 x 3.1	4.1	LRH007A6-E	8 x 8 x 6	11.1
Mbbb-03400031	No	7.6	3000	37.2	LRM007A6-C	5 x 4.4 x 2.8	2.8	LRM007A6-E	8 x 8 x 6	9.8
Mbbb-03400045	No	11	2100	40.9	LRM0011A-C	5 x 4.4 x 3.1	4.2	LRM0011A-E	8 x 8 x 6	11.2
Mbbb-03400062	No	14	1600	48.2	LRM0014A-C	5 x 4.4 x 3.1	4.3	LRM0014A-E	8 x 8 x 6	11.3
Mbbb-03400078	Yes	14	1600	48.2	LRM0014A-C	5 x 4.4 x 3.1	4.3	LRM0014A-E	8 x 8 x 6	11.3
Mbbb-03400100	Yes	21	1100	57.4	LRM0021A-C	6.1 x 6 x 2.6	7.2	LRM0021A-E	13.3 x 13.2 x 13.1	25.2
Mbbb-04400150	Yes	21	1100	57.4	LRM0021A-C	6.1 x 6 x 2.6	7.2	LRM0021A-E	13.3 x 13.2 x 13.1	25.2
Mbbb-04400172	Yes	28	820	68.8	LRM0028A-C	6.1 x 6 x 3.3	9	LRM0028A-E	13.3 x 13.2 x 13.1	28.4
Mddd-09402000	No	250	95	284	LRM0250A-C	7.5 x 9.3 x 8.5	55	LRM0250A-E	24 x 16.9 x 18.4	82
Mddd-09402240	No	322	70	383	LRM0322A-C	8.8 x 10.8 x 8.5	76	LRM0322A-E	47 x 26.5 x 24.9	220
Mbbb-10402700	No	322	70	383	LRM0322A-C	8.8 x 10.8 x 8.5	76	LRM0322A-E	47 x 26.5 x 24.9	220
Mbbb-10403200	No	414	66	531	LRM0414A-C	8.8 x 9 x 11.5	98	LRM0414A-E	47 x 26.5 x 24.9	242
Mccc-05400270	No	35	710	102	LRM0035A-C	6 x 7.2 x 3.8	13	LRM0035A-E	13.3 x 13.2 x 13.1	31
Mccc-05400300	Yes	35	710	102	LRM0035A-C	6 x 7.2 x 3.8	13	LRM0035A-E	13.3 x 13.2 x 13.1	31
Mccc-06400350	Yes	46	550	99	LRM0046A-C	6 x 7.2 x 4.3	17	LRM0046A-E	13.3 x 13.2 x 13.1	35
Mccc-06400420	Yes	46	550	99	LRM0046A-C	6 x 7.2 x 4.3	17	LRM0046A-E	13.3 x 13.2 x 13.1	35
Mccc-06400470	Yes	65	380	105	LRM0065A-C	6 x 7.2 x 4.3	22	LRM0065A-E	13.3 x 13.2 x 13.1	40
Mddd-07400660	Yes	83	290	155	LRM0083A-C	7 x 9 x 6.5	26	LRM0083A-E	13.3 x 13.2 x 13.1	44
Mddd-07400770	Yes	104	230	200	LRM0104A-C	7 x 9 x 7	28	LRM0104A-E	13.3 x 13.2 x 13.1	46
Mddd-07401000	Yes	130	180	197	LRM0130A-C	7.5 x 9.3 x 6.8	37	LRM0130A-E	13.3 x 13.2 x 13.1	55
Mddd-08401340	Yes	160	155	195	LRM0160A-C	7.5 x 9.3 x 8.3	49	LRM0160A-E	13.3 x 13.2 x 13.1	67
Mddd-08401570	Yes	200	115	224	LRM0200A-C	7.5 x 9.3 x 8.3	49	LRM0200A-E	24 x 16.9 x 18.4	82

aaa = Unidrive M100, M101, M200, M201, M300 & M400
 bbb = Unidrive M600, M700, M701, M702, HS70, HS71, HS72
 ccc = Unidrive M200, M201, M300, M400, M600, M700, M701, M702, HS70, HS71, HS72
 ddd = Unidrive M400, M600, M700, M701, M702, HS70, HS71, HS72

Line reactors are recommended for AC drives that do not include a built-in inductor.
 For drive modules that include DC or AC inductors built in, the line reactors above provide additional impedance.



Output Load Reactors - 460 Vac



Load Reactor 1.5%

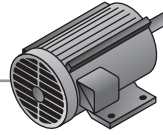
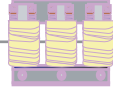

460 Vac, 3 Phase									
Drive	Amps	Inductance (μH)	Watts Loss	Chassis Mount			NEMA 1 Enclosed		
				Order Code	Dims. (in) H x W x D	Weight (lbs)	Order Code	Dims. (in) H x W x D	Weight (lbs)
Maaa-02400013	2.1	11000	14.3	LRM002A1-C	3.7 x 4.5 x 1.5	1.6	LRM002A1-E	8 x 8 x 6	8.6
Maaa-02400018	3.4	6800	19.6	LRM003A4-C	3.7 x 4.5 x 1.5	1.6	LRM003A4-E	8 x 8 x 6	8.6
Maaa-02400023	3.4	6800	19.6	LRM003A4-C	3.7 x 4.5 x 1.5	1.6	LRM003A4-E	8 x 8 x 6	8.6
Maaa-02400032	4.8	4800	23	LRM004A8-C	3.7 x 4.5 x 1.5	1.8	LRM003A4-E	8 x 8 x 6	8.6
Maaa-02400041	7.6	3000	37.2	LRM007A6-C	5 x 4.4 x 2.8	2.8	LRM007A6-E	8 x 8 x 6	9.8
Maaa-03400056	7.6	1500	19.2	LRL007A6-C	3.7 x 4.5 x 1.5	1.8	LRL007A6-E	8 x 8 x 6	8.8
Maaa-03400073	11	2100	40.9	LRM0011A-C	5 x 4.4 x 3.1	4.2	LRM0011A-E	8 x 8 x 6	11.2
Maaa-03400094	14	1600	48.2	LRM0014A-C	5 x 4.4 x 3.1	4.3	LRM0014A-E	8 x 8 x 6	11.3
Maaa-04400135	21	1100	57.4	LRM0021A-C	6.1 x 6 x 2.6	7.2	LRM0021A-E	13.3 x 13.2 x 13.1	25.2
Maaa-04400170	21	530	38.3	LRL0021A-C	5.3 x 4.4 x 3.3	4.2	LRL0021A-E	13.3 x 13.2 x 13.1	22.2
Mbbb-03400025	4.8	4800	23	LRM004A8-C	3.7 x 4.5 x 1.5	1.8	LRM003A4-E	8 x 8 x 6	8.6
Mbbb-03400031	7.6	3000	37.2	LRM007A6-C	5 x 4.4 x 2.8	2.8	LRM007A6-E	8 x 8 x 6	9.8
Mbbb-03400045	11	2100	40.9	LRM0011A-C	5 x 4.4 x 3.1	4.2	LRM0011A-E	8 x 8 x 6	11.2
Mbbb-03400062	11	2100	40.9	LRM0011A-C	5 x 4.4 x 3.1	4.2	LRM0011A-E	8 x 8 x 6	11.2
Mbbb-03400078	14	1600	48.2	LRM0014A-C	5 x 4.4 x 3.1	4.3	LRM0014A-E	8 x 8 x 6	11.3
Mbbb-03400100	21	1100	57.4	LRM0021A-C	6.1 x 6 x 2.6	7.2	LRM0021A-E	13.3 x 13.2 x 13.1	25.2
Mbbb-04400150	28	820	68.8	LRM0028A-C	6.1 x 6 x 3.3	9	LRM0028A-E	13.3 x 13.2 x 13.1	28.4
Mbbb-04400172	35	710	102	LRM0035A-C	6 x 7.2 x 3.8	13	LRM0035A-E	13.3 x 13.2 x 13.1	31
Mddd-09402000	322	50	300	LRL0322A-C	7.5 x 9.3 x 9	57	LRL0322A-E	24 x 16.9 x 18.4	84
Mddd-09402240	414	33	333	LRL0414A-C	8.8 x 9 x 9.5	78	LRL0414A-E	47 x 26.5 x 24.9	222
Mbbb-10400270	414	33	333	LRL0414A-C	8.8 x 9 x 9.5	78	LRL0414A-E	47 x 26.5 x 24.9	222
Mbbb-10403200	515	25	314	LRL0515A-C	8.8 x 9 x 9.5	81	LRL0515A-E	47 x 26.5 x 24.9	225
Mccc-05400270	46	300	77	LRL0046A-C	6 x 7.2 x 3.8	13	LRL0046A-E	13.3 x 13.2 x 13.1	31
Mccc-05400300	46	300	77	LRL0046A-C	6 x 7.2 x 3.8	13	LRL0046A-E	13.3 x 13.2 x 13.1	31
Mccc-06400350	55	270	67	LRL0055A-C	6 x 7.2 x 4	18	LRL0055A-E	13.3 x 13.2 x 13.1	36
Mccc-06400420	65	190	87	LRL0065A-C	6 x 7.2 x 4	18	LRL0065A-E	13.3 x 13.2 x 13.1	36
Mccc-06400470	83	170	119	LRL0083A-C	6 x 7.2 x 4.3	19	LRL0083A-E	13.3 x 13.2 x 13.1	37
Mddd-07400660	104	120	94	LRL0104A-C	6 x 7.2 x 6.5	22	LRL0104A-E	13.3 x 13.2 x 13.1	40
Mddd-07400770	130	95	132	LRL0130A-C	7.5 x 9.3 x 6.8	26	LRL0130A-E	13.3 x 13.2 x 13.1	44
Mddd-07401000	160	80	110	LRL0160A-C	7.5 x 9.3 x 6.8	34	LRL0160A-E	13.3 x 13.2 x 13.1	52
Mddd-08401340	200	60	159	LRL0200A-C	7.5 x 9.3 x 7.0	34	LRL0200A-E	24 x 16.9 x 18.4	61
Mddd-08401570	250	50	275	LRL0250A-C	7.5 x 9.5 x 7.5	35	LRL0250A-E	24 x 16.9 x 18.4	62

aaa = Unidrive M100, M101, M200, M201, M300 & M400
 bbb = Unidrive M600, M700, M701, M702, HS70, HS71, HS72
 ccc = Unidrive M200, M201, M300, M400, M600, M700, M701, M702, HS70, HS71, HS72
 ddd = Unidrive M400, M600, M700, M701, M702, HS70, HS71, HS72

Consult factory for different percentage impedance and NEMA 3R outdoor enclosure options.



Input Line Reactors - 575 Vac & 690 Vac

Line Reactor 3%

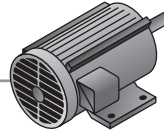
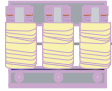

575 Vac, 3 Phase 50/60 Hz										
Drive	Built-In Inductor	Amps	Inductance (μH)	Watts Loss	Chassis Mount			NEMA 1 Enclosed		
					Order Code	Dims. (in) H x W x D	Weight (lbs)	Order Code	Dims. (in) H x W x D	Weight (lbs)
Mbbb-05500030	Yes	4.8	7700	37.5	LRH004A8-C	5 x 4.4 x 2.8	2.8	LRH004A8-E	8 x 8.1 x 6.1	8.6
Mbbb-05500040	Yes	7.6	4800	47.8	LRH007A6-C	5 x 4.4 x 3.1	4.1	LRH007A6-E	8 x 8 x 6	11.1
Mbbb-05500069	Yes	11	2100	40.9	LRM0011A-C	5 x 4.4 x 3.1	4.2	LRM0011A-E	8 x 8 x 6	11.2
Mbbb-06500100	Yes	14	2600	60.6	LRH0014A-C	5.8 x 6 x 2.9	7.1	LRH0014A-E	8 x 8.1 x 6.1	12.3
Mbbb-06500150	Yes	21	1800	73.5	LRH0021A-C	6.1 x 6 x 3.3	10	LRH0021A-E	13.3 x 13.2 x 13.1	28
Mbbb-06500190	Yes	28	1300	93.8	LRH0028A-C	6.1 x 6 x 3.3	10.4	LRH0028A-E	13.3 x 13.2 x 13.1	28.4
Mbbb-06500230	Yes	35	1200	121	LRH0035A-C	6 x 7.2 x 4.3	18	LRH0035A-E	13.3 x 13.2 x 13.1	27
Mbbb-06500290	Yes	46	550	99	LRM0046A-C	6 x 7.2 x 4.3	17	LRM0046A-E	13.3 x 13.2 x 13.1	35
Mbbb-06500350	Yes	55	480	109	LRM0055A-C	6 x 7.2 x 4.3	20	LRM0055A-E	13.3 x 13.2 x 13.1	38
Mccc-07500440	Yes	46	550	99	LRM0046A-C	6 x 7.2 x 4.3	17	LRM0046A-E	13.3 x 13.2 x 13.1	35
Mccc-07500550	Yes	65	380	105	LRM0065A-C	6 x 7.2 x 4.3	22	LRM0065A-E	13.3 x 13.2 x 13.1	40
Mccc-08500630	Yes	83	290	155	LRM0083A-C	7 x 9 x 6.5	26	LRM0083A-E	13.3 x 13.2 x 13.1	44
Mccc-08500860	Yes	104	230	200	LRM0104A-C	7 x 9 x 7	28	LRM0104A-E	13.3 x 13.2 x 13.1	46
Mccc-09501040	No	130	180	197	LRM0130A-C	7.5 x 9.3 x 6.8	37	LRM0130A-E	13.3 x 13.2 x 13.1	55
Mccc-09501310	No	160	155	195	LRM0160A-C	7.5 x 9.3 x 8.3	49	LRM0160A-E	13.3 x 13.2 x 13.1	67
Mddd-10501520	No	250	95	284	LRM0250A-C	7.5 x 9.3 x 8.5	55	LRM0250A-E	24 x 16.9 x 18.4	82

bbb = Unidrive M200, M201, M300, M400, M600, M700, M701, M702, HS70, HS71, HS72

ccc = Unidrive M400, M600, M700, M701, M702, HS70, HS71, HS72

ddd = Unidrive M600, M700, M701, M702, HS70, HS71, HS72

690 Vac, 3 Phase 50/60 Hz										
Drive	Built-in Inductor	Amps	Inductance (μH)	Watts Loss	Chassis Mount			NEMA 1 Enclosed		
					Order Code	Dims. (in) H x W x D	Weight (lbs)	Order Code	Dims. (in) H x W x D	Weight (lbs)
Mccc-07600190	Yes	21	1800	73.5	LRH0021A-C	6.1 x 6 x 3.3	10	LRH0021A-E	13.3 x 13.2 x 13.1	28
Mccc-07600240	Yes	28	1300	93.8	LRH0028A-C	6.1 x 6 x 3.3	10.4	LRH0028A-E	13.3 x 13.2 x 13.1	28.4
Mccc-07600290	Yes	35	1200	121	LRH0035A-C	6 x 7.2 x 4.3	18	LRH0035A-E	13.3 x 13.2 x 13.1	27
Mccc-07600380	Yes	46	980	179	LRH0046A-C	8.3 x 9 x 4.8	24	LRH0046A-E	13.3 x 13.2 x 13.1	35
Mccc-07600440	Yes	46	980	179	LRH0046A-C	8.3 x 9 x 4.8	24	LRH0046A-E	13.3 x 13.2 x 13.1	35
Mccc-07600540	Yes	65	640	214	LRH0065A-C	7 x 9 x 6.5	26	LRH0065A-E	13.3 x 13.2 x 13.1	40
Mccc-08500630	Yes	83	510	197	LRH0083A-C	7 x 9 x 6.8	35	LRH0083A-E	13.3 x 13.2 x 13.1	44
Mccc-08500860	Yes	104	375	208	LRH0104A-C	7 x 7.3 x 7.3	41	LRH0104A-E	13.3 x 13.2 x 13.1	46
Mccc-09601040	No	130	300	197	LRH0130A-C	7.5 x 9.3 x 8.3	52	LRH0130A-E	13.3 x 13.2 x 13.1	55
Mccc-09601310	No	160	260	309	LRH0160A-C	7.5 x 9.3 x 8.3	53	LRH0160A-E	24 x 17.1 x 18.4	67
Mddd-10601500	No	200	200	293	LRH0200A-C	8.3 x 10.8 x 9	75	LRM0200A-E	24 x 16.9 x 18.4	82
Mddd-10601780	No	200	200	293	LRH0200A-C	8.3 x 10.8 x 9	75	LRM0200A-E	24 x 16.9 x 18.4	82

bbb = Unidrive M600, M700, M701, M702, HS70, HS71, HS72

ccc = Unidrive M400, M600, M700, M701, M702, HS70, HS71, HS72

ddd = Unidrive M600, M700, M701, M702, HS70, HS71, HS72

*Note - for use with 600V supplies only.

Consult factory for different percentage impedance requirements and NEMA 3R outdoor enclosure options.



Output Load Reactors - 575 Vac & 690 Vac



Load Reactor 1.5%

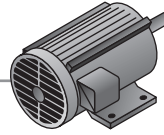
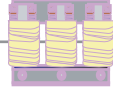

575 Vac, 3 Phase									
Drive	Amps	Inductance (μH)	Watts Loss	Chassis Mount			NEMA 1 Enclosed		
				Order Code	Dims. (in) H x W x D	Weight (lbs)	Order Code	Dims. (in) H x W x D	Weight (lbs)
Mddd-09501040	160	80	110	LRL0160A-C	7.5 x 9.3 x 6.8	34	LRL0160A-E	13.3 x 13.2 x 13.1	52
Mddd-09501310	200	115	224	LRM0200A-C	7.5 x 9.3 x 8.3	49	LRM0200A-E	24 x 16.9 x 18.4	82
Mbbb-10501520	250	95	284	LRM0250A-C	7.5 x 9.3 x 8.5	55	LRM0250A-E	24 x 16.9 x 18.4	82
Mccc-05500030	7.6	4800	47.8	LRH007A6-C	5 x 4.4 x 3.1	4.1	LRH007A6-E	8 x 8 x 6	11.1
Mccc-05500040	11	2100	40.9	LRM0011A-C	5 x 4.4 x 3.1	4.2	LRM0011A-E	8 x 8 x 6	11.2
Mccc-05500069	14	1600	48.2	LRM0014A-C	5 x 4.4 x 3.1	4.3	LRM0014A-E	8 x 8 x 6	11.3
Mccc-06500100	21	1800	73.5	LRH0021A-C	6.1 x 6 x 3.3	10	LRH0021A-E	13.3 x 13.2 x 13.1	28
Mccc-06500150	28	820	68.8	LRM0028A-C	6.1 x 6 x 3.3	9	LRM0028A-E	13.3 x 13.2 x 13.1	28.4
Mccc-06500190	28	820	68.8	LRM0028A-C	6.1 x 6 x 3.3	9	LRM0028A-E	13.3 x 13.2 x 13.1	28.4
Mccc-06500230	35	400	49	LRL0035A-C	6 x 6 x 3.5	10	LRL0035A-E	13.3 x 13.2 x 13.1	28
Mccc-06500290	46	300	77	LRL0046A-C	6 x 7.2 x 3.8	13	LRL0046A-E	13.3 x 13.2 x 13.1	31
Mccc-06500350	55	270	67	LRL0055A-C	6 x 7.2 x 4	18	LRL0055A-E	13.3 x 13.2 x 13.1	36
Mddd-07500440	83	290	155	LRM0083A-C	7 x 9 x 6.5	26	LRM0083A-E	13.3 x 13.2 x 13.1	44
Mddd-07500550	104	230	200	LRM0104A-C	7 x 9 x 7	28	LRM0104A-E	13.3 x 13.2 x 13.1	46
Mddd-08500630	130	180	197	LRM0130A-C	7.5 x 9.3 x 6.8	37	LRM0130A-E	13.3 x 13.2 x 13.1	55
Mddd-08500860	160	155	195	LRM0160A-C	7.5 x 9.3 x 8.3	49	LRM0160A-E	13.3 x 13.2 x 13.1	67

bbb = Unidrive M600, M700, M701, M702, HS70, HS71, HS72

ccc = Unidrive M200, M201, M300, M400, M600, M700, M701, M702, HS70, HS71, HS72

ddd = Unidrive M400, M600, M700, M701, M702, HS70, HS71, HS72

690 Vac, 3 Phase									
Drive	Amps	Inductance (μH)	Watts Loss	Chassis Mount			NEMA 1 Enclosed		
				Order Code	Dims. (in) H x W x D	Weight (lbs)	Order Code	Dims. (in) H x W x D	Weight (lbs)
Mddd-09601040	160	155	195	LRM0160A-C	7.5 x 9.3 x 8.3	49	LRM0160A-E	13.3 x 13.2 x 13.1	67
Mddd-09601310	200	115	224	LRM0200A-C	7.5 x 9.3 x 8.3	49	LRM0200A-E	24 x 16.9 x 18.4	82
Mbbb-10601500	250	95	284	LRM0250A-C	7.5 x 9.3 x 8.5	55	LRM0250A-E	24 x 16.9 x 18.4	82
Mbbb-10601780	250	95	284	LRM0250A-C	7.5 x 9.3 x 8.5	55	LRM0250A-E	24 x 16.9 x 18.4	82
Mddd-07600190	35	710	102	LRM0035A-C	6 x 7.2 x 3.8	13	LRM0035A-E	13.3 x 13.2 x 13.1	31
Mddd-07600240	46	550	99	LRM0046A-C	6 x 7.2 x 4.3	17	LRM0046A-E	13.3 x 13.2 x 13.1	35
Mddd-07600290	46	550	99	LRM0046A-C	6 x 7.2 x 4.3	17	LRM0046A-E	13.3 x 13.2 x 13.1	35
Mddd-07600380	65	380	105	LRM0065A-C	6 x 7.2 x 4.3	22	LRM0065A-E	13.3 x 13.2 x 13.1	40
Mddd-07600440	65	380	105	LRM0065A-C	6 x 7.2 x 4.3	22	LRM0065A-E	13.3 x 13.2 x 13.1	40
Mddd-07600540	104	230	200	LRM0104A-C	7 x 9 x 7	28	LRM0104A-E	13.3 x 13.2 x 13.1	46
Mddd-08500630	130	180	197	LRM0130A-C	7.5 x 9.3 x 6.8	37	LRM0130A-E	13.3 x 13.2 x 13.1	55
Mddd-08500860	160	155	195	LRM0160A-C	7.5 x 9.3 x 8.3	49	LRM0160A-E	13.3 x 13.2 x 13.1	67

bbb = Unidrive M600, M700, M701, M702, HS70, HS71, HS72

ddd = Unidrive M400, M600, M700, M701, M702, HS70, HS71, HS72

* Note - for use with 600V supplies only.

Consult factory for different percentage impedance and NEMA 3R outdoor enclosure options.



Isolation Transformers

Drive isolation transformers add an extra margin of protection for AC drives. They are sized to the drive kVA requirements and are designed to withstand the mechanical stress of current reversals and short circuits associated with power semiconductor type AC drives.

- Three-coil, delta-wye configuration with fully rated NEMA 1 enclosure
- ±5% fully rated taps on primary winding
- Ambient temperature: 104 °F (40 °C)
- Standards: ANSI C89.2, NEMA ST-20, UL506, UL1561

Features:

- Provide electrical isolation between the incoming line and the drive electronics
- Convert input line voltage to standard drive input voltages
- Minimize line disturbances caused by SCR power converters
- Reduce power line harmonics caused by drives
- Protect the motor controller by reducing available short circuit potential. This may be a UL requirement in installations with high levels of short circuit potential



Size	Wt. (lbs)	HP	kVA	Primary Voltage	Secondary Voltage		
					230Vac	460Vac	
A	150	5	7.5	230	8812-0007-1	8812-0007-2	
				460	8812-0007-3	8812-0007-4	
	160	7.5	11	230	8812-0011-1	8812-0011-2	
				460	8812-0011-3	8812-0011-4	
	170	10	14	230	8812-0014-1	8812-0014-2	
				460	8812-0014-3	8812-0014-4	
B	240	15	20	230	8812-0020-1	8812-0020-2	
				460	8812-0020-3	8812-0020-4	
	300	20	27	230	8812-0027-1	8812-0027-2	
				460	8812-0027-3	8812-0027-4	
	330	25	34	230	8812-0034-1	8812-0034-2	
				460	8812-0034-3	8812-0034-4	
	350	30	40	230	8812-0040-1	8812-0040-2	
				460	8812-0040-3	8812-0040-4	
	430	40	51	230	8812-0051-1	8812-0051-2	
				460	8812-0051-3	8812-0051-4	
	C	530	50	63	230	8812-0063-1	8812-0063-2
					460	8812-0063-3	8812-0063-4
580		60	75	230	8812-0075-1	8812-0075-2	
				460	8812-0075-3	8812-0075-4	
630		75	93	230	8812-0093-1	8812-0093-2	
				460	8812-0093-3	8812-0093-4	
730	100	118	230	8812-0118-1	8812-0118-2		
			460	8812-0118-3	8812-0118-4		
D	830	125	145	230	8812-0145-1	8812-0145-2	
				460	8812-0145-3	8812-0145-4	
	930	150	175	230	8812-0175-1	8812-0175-2	
				460	8812-0175-3	8812-0175-4	
	1350	200	220	230	8812-0220-1	8812-0220-2	
				460	8812-0220-3	8812-0220-4	
E	1500	250	275	230	8812-0275-1	8812-0275-2	
				460	8812-0275-3	8812-0275-4	
	1700	300	330	230	8812-0330-1	8812-0330-2	
460				8812-0330-3	8812-0330-4		
F	2100	400	440	460		8812-0440-4	
	2350	500	550	460		8812-0550-4	

Order Code

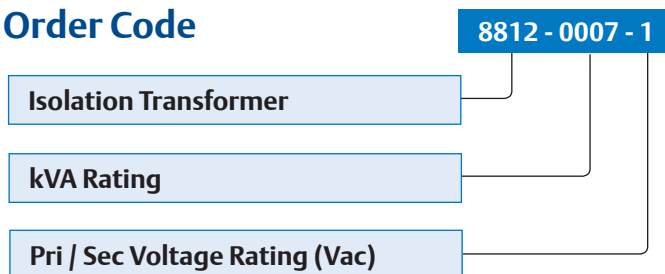

Size	Dims. (in) H x W x D
A	21.5 x 19.4 x 20.2
B	28.8 x 23.9 x 25
C	38 x 26 x 25
D	41 x 32 x 29.5
E	51.5 x 39.5 x 34
F	59 x 48.5 x 38.4

Drive EMC Filters

Electromagnetic Compatibility Filters

EMC filters are used to minimize high-frequency power supply line disturbances caused by drives that may interfere with proper operation of sensitive electronic equipment. These specific filters have been assessed for conformance with the EMC directive by testing with the appropriate Control Techniques brand drives.

EMC data sheets are available for digital drive products. These data sheets list the applicable harmonic standards and give recommended installation techniques and further information on EMC behavior in typical situations.

All Emerson AC Control Techniques drives include internal EMC filters. The filters listed in the following tables are used in addition

to the standard onboard filter to provide additional interference reduction. Refer to the specific drive EMC data sheets for details of levels of compliance with IEC standards.

Filter Types

- Low Leakage: low leakage filters limit the leakage current to ground. The length of the motor cable is severely restricted when these filters are applied.
- Standard: standard filters are designed for use in industrial or residential applications with longer motor lead lengths.



EMC (RFI) Filters

115 Vac, Single Phase

Frame	Type	Order Code	Compatibility			
			M100	M200-300	M400	M600-700
1	Standard	4200-1000	Y	Y	Y	
1	Low leakage	4200-1001	Y	Y	Y	
2	Standard	4200-2000	Y	Y	Y	

230 Vac, Single Phase

Frame	Type	Order Code	Compatibility			
			M100	M200-300	M400	M600-700
1	Standard	4200-1000	Y	Y	Y	
1	Low leakage	4200-1001	Y	Y	Y	
2	Standard	4200-2001	Y	Y	Y	
2	Low leakage	4200-2002	Y	Y	Y	
3	Standard	4200-3000	Y	Y	Y	
3	Low leakage	4200-3001	Y	Y	Y	
4	Standard	4200-4000	Y	Y	Y	

230V, 3 Phase

Frame	Type	Order Code	Compatibility			
			M100	M200-300	M400	M600-700
2	Standard	4200-2003	Y	Y	Y	
2	Low leakage	4200-2004	Y	Y	Y	
3	Standard	4200-3230				Y
4	Standard	4200-4002	Y	Y	Y	
4	Low leakage	4200-4003	Y	Y	Y	
4	Standard	4200-0272				Y
5	Standard	4200-0312		Y	Y	Y
6	Standard	4200-2300		Y	Y	Y
7	Standard	4200-1072		Y	Y	Y
8	Standard	4200-1672		Y	Y	Y
9/10/11	Standard		Consult Factory			

460 Vac, 3 Phase

Frame	Type	Order Code	Compatibility			
			M100	M200-300	M400	M600-700
2	Standard	4200-2005	Y	Y	Y	
2	Low leakage	4200-2006	Y	Y	Y	
3	Standard	4200-3008	Y	Y	Y	
3	Low leakage	4200-3009	Y	Y	Y	
3	Standard	4200-3480				Y
4	Standard	4200-4002	Y	Y	Y	
4	Low leakage	4200-4003	Y	Y	Y	
4	Standard	4200-0252				Y
5	Standard	4200-0402		Y	Y	Y
6	Standard	4200-4800		Y	Y	Y
7	Standard	4200-1132		Y	Y	Y
8	Standard	4200-1972		Y	Y	Y
9/10/11	Standard		Consult Factory			

575 Vac and 690 Vac, 3 Phase

Frame	Type	Order Code	Compatibility			
			M100	M200-300	M400	M600-700
5	Standard	4200-0122		Y	Y	Y
6	Standard	4200-3690		Y	Y	Y
7	Standard	4200-0672*		Y	Y	Y
8	Standard	4200-1662*		Y	Y	Y
9/10/11	Standard		Consult Factory			

* 690 Vac and 575 Vac

Dynamic Braking Resistors

Dynamic Braking (DB)

The DC bus voltage level of an AC drive increases while the motor is re-generating (i.e. ramping to a stop). Dynamic braking resistors provide a means of rapidly stopping a rotating motor and load while maintaining an acceptable bus voltage level. The kinetic energy stored in the spinning mass is converted into electrical energy and quickly dissipated as heat through a resistor.

Dynamic Braking for AC Drives

AC drives provide a constant torque stopping profile when a dynamic brake resistor is applied across the DC bus circuit. Dynamic braking can be employed under a stop command or anytime a decrease in motor speed is commanded, provided the AC drive is enabled and programmed for ramp stop (fast ramp mode).

Two types of dynamic braking kits are available for Control Techniques AC Drives. The E-stop duty kits are rated for light start/stop or deceleration duty cycles.

The cyclic duty kits are intended for heavy duty applications that need the capability to dissipate regenerated energy on a more continuous or repetitive basis such as downhill conveyors, hoists, feeders and dynamometers.

E-Stop Duty

E-stop duty DB resistors are designed for absorbing energy generated by infrequent motor stops or deceleration.

These kits are designed to meet or exceed NEMA standard 7-15-1970, which states "DB resistors will not exceed their rated temperature rise when the drive is braked from maximum speed to standstill three times in rapid succession with a load inertia equal to or less than the motor inertia." They are designed to provide 150% braking torque for 1800rpm base speed motors.

Cyclic Duty

The standard packages listed below are NEMA 1 rated and include built-in junction box, terminal strip, normally closed thermal contact (klixon switch) and resistors pre-wired with high-temperature Teflon wire.

These heavy-duty kits have been designed to provide dynamic braking for cyclic and continuous braking applications. There are three levels available: 10%, 25% and 50%. These levels refer to the continuous allowable braking level (i.e. 25% refers to 25% of rated motor braking torque) or the maximum allowable duty cycle rates with maximum specified "on-time" limitations (refer to illustration below).



Galvanized NEMA1 with normally closed thermostat

$$\text{Duty Cycle} = \frac{\text{On Time } (\leq \text{max "on" time})}{\text{On Time} + \text{Off Time}}$$

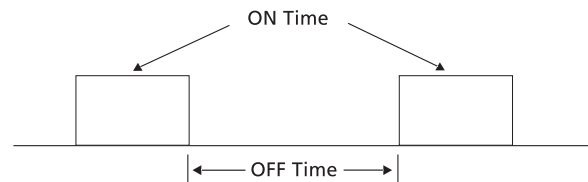

Dynamic Braking Resistors

DB Resistors for AC Drives

Unidrive M drives are equipped with built-in dynamic braking transistors. Simply select the proper braking resistor needed for the size of drive and duty cycle.

Other mounting arrangements and enclosures are available on request.

The brake circuit must include an external thermal protection device connected (as shown in the circuit diagram) unless the resistor has built-in protection.

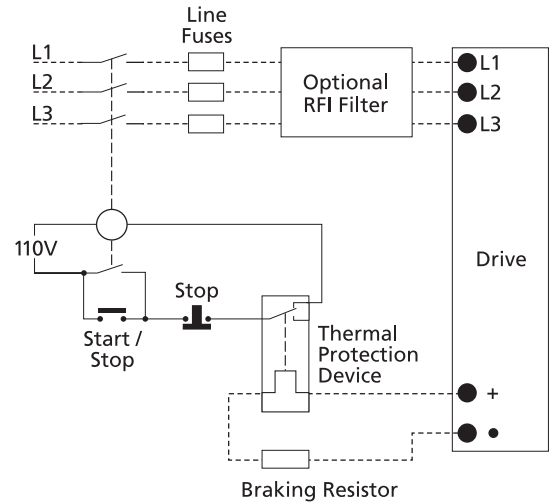

Dynamic Braking Resistors - 230 Vac

Galvanized NEMA 1 Enclosed

Drives	Heavy Duty HP	E-Stop Duty - NEMA 1 Normally Closed Thermostat		10% Duty Rated Normally Closed Thermostat		25% Duty Rated Normally Closed Thermostat		50% Duty Rated Normally Closed Thermostat	
		Order Code	Dims. (in) H x W x D	Order Code	Dims. (in) H x W x D	Order Code	Dims. (in) H x W x D	Order Code	Dims. (in) H x W x D
Maaa-01100017	0.33	DBR-1500-00300-ENC	5 x 14 x 4	DBR-1500-00300-ENC	5 x 14 x 4	DBR-1500-00300-ENC	5 x 14 x 4	DBR-1500-00300-ENC	5 x 14 x 4
Maaa-01100024	0.5	DBR-1500-00300-ENC	5 x 14 x 4	DBR-1500-00300-ENC	5 x 14 x 4	DBR-1500-00300-ENC	5 x 14 x 4	DBR-1500-00300-ENC	5 x 14 x 4
Maaa-02100042	1	DBR-1500-00300-ENC	5 x 14 x 4	DBR-1500-00300-ENC	5 x 14 x 4	DBR-1500-00300-ENC	5 x 14 x 4	DBR-1500-00600-ENC	5 x 14 x 4
Maaa-02100056	1.5	DBR-1500-00300-ENC	5 x 14 x 4	DBR-1500-00300-ENC	5 x 14 x 4	DBR-1500-00300-ENC	5 x 14 x 4	DBR-1500-00600-ENC	5 x 14 x 4
Maaa-01200017	0.33	DBR-1500-00300-ENC	5 x 14 x 4	DBR-1500-00300-ENC	5 x 14 x 4	DBR-1500-00300-ENC	5 x 14 x 4	DBR-1500-00300-ENC	5 x 14 x 4
Maaa-01200024	0.5	DBR-1500-00300-ENC	5 x 14 x 4	DBR-1500-00300-ENC	5 x 14 x 4	DBR-1500-00300-ENC	5 x 14 x 4	DBR-1500-00300-ENC	5 x 14 x 4
Maaa-01200033	0.75	DBR-1500-00300-ENC	5 x 14 x 4	DBR-1500-00300-ENC	5 x 14 x 4	DBR-1500-00300-ENC	5 x 14 x 4	DBR-1500-00300-ENC	5 x 14 x 4
Maaa-01200042	1	DBR-1500-00300-ENC	5 x 14 x 4	DBR-1500-00300-ENC	5 x 14 x 4	DBR-1500-00300-ENC	5 x 14 x 4	DBR-1500-00600-ENC	5 x 14 x 4
Maaa-02200024	0.5	DBR-0800-00300-ENC	5 x 14 x 4	DBR-0800-00300-ENC	5 x 14 x 4	DBR-0800-00300-ENC	5 x 14 x 4	DBR-0800-00300-ENC	5 x 14 x 4
Maaa-02200033	0.75	DBR-0800-00300-ENC	5 x 14 x 4	DBR-0800-00300-ENC	5 x 14 x 4	DBR-0800-00300-ENC	5 x 14 x 4	DBR-0800-00300-ENC	5 x 14 x 4
Maaa-02200042	1	DBR-0800-00300-ENC	5 x 14 x 4	DBR-0800-00300-ENC	5 x 14 x 4	DBR-0800-00300-ENC	5 x 14 x 4	DBR-0800-00600-ENC	5 x 14 x 4
Maaa-02200056	1.5	DBR-0800-00300-ENC	5 x 14 x 4	DBR-0800-00300-ENC	5 x 14 x 4	DBR-0800-00300-ENC	5 x 14 x 4	DBR-0800-00600-ENC	5 x 14 x 7
Maaa-02200075	2	DBR-0800-00300-ENC	5 x 14 x 4	DBR-0800-00300-ENC	5 x 14 x 4	DBR-0800-00300-ENC	5 x 14 x 7	DBR-0800-01500-ENC	5 x 14 x 13
Maaa-03200100	3	DBR-0500-00300-ENC	5 x 14 x 4	DBR-0500-00300-ENC	5 x 14 x 4	DBR-0500-01500-ENC	5 x 14 x 13	DBR-0500-01000-ENC	14 x 13 x 5
Maaa-04200133	3	DBR-0300-00400-ENC	5 x 14 x 4	DBR-0300-00600-ENC	5 x 14 x 7	DBR-0300-01500-ENC	5 x 14 x 4	DBR-0300-01500-ENC	5 x 14 x 4
Maaa-04200176	5	DBR-0200-00400-ENC	5 x 14 x 4	DBR-0200-00600-ENC	5 x 14 x 7	DBR-0200-01500-ENC	5 x 14 x 13	DBR-0200-03000-ENC	5 x 28 x 13
Mbbb-03200050	1	DBR-0500-00300-ENC	5 x 14 x 4	DBR-0500-00300-ENC	5 x 14 x 4	DBR-0500-00500-ENC	5 x 14 x 7	DBR-0500-01500-ENC	5 x 14 x 13
Mbbb-03200066	1.5	DBR-0500-00300-ENC	5 x 14 x 4	DBR-0500-00300-ENC	5 x 14 x 4	DBR-0500-00500-ENC	5 x 14 x 7	DBR-0500-01500-ENC	5 x 14 x 13
Mbbb-03200080	2	DBR-0500-00300-ENC	5 x 14 x 4	DBR-0500-00300-ENC	5 x 14 x 4	DBR-0500-00500-ENC	5 x 14 x 7	DBR-0500-01500-ENC	5 x 14 x 13
Mbbb-03200106	3	DBR-0400-00300-ENC	5 x 14 x 4	DBR-0400-00300-ENC	5 x 14 x 4	DBR-0350-01500-ENC	5 x 14 x 13	DBR-0350-01500-ENC	5 x 14 x 13
Mbbb-04200137	3	DBR-0200-00400-ENC	5 x 14 x 4	DBR-0200-00600-ENC	5 x 14 x 7	DBR-0200-01500-ENC	5 x 14 x 13	DBR-0200-01500-ENC	5 x 14 x 13
Mbbb-04200185	5	DBR-0200-00400-ENC	5 x 14 x 4	DBR-0200-00600-ENC	5 x 14 x 7	DBR-0200-01500-ENC	5 x 14 x 13	DBR-0200-03000-ENC	5 x 28 x 13
Mccc-05200250	7.5	DBR-0200-00400-ENC	5 x 14 x 4	DBR-0200-00600-ENC	5 x 14 x 7	DBR-0200-01500-ENC	5 x 14 x 13	DBR-0200-03000-ENC	5 x 28 x 13
Mccc-06200330	10	DBR-0100-00600-ENC	5 x 14 x 7	DBR-0100-00900-ENC	5 x 14 x 10	DBR-0100-03000-ENC	5 x 21 x 13	DBR-0100-04500-ENC	5 x 28 x 13
Mccc-06200440	15	DBR-0100-00600-ENC	5 x 14 x 7	DBR-0100-01200-ENC	5 x 14 x 10	DBR-0100-03000-ENC	5 x 21 x 13	DBR-0100-06000-ENC	7 x 29 x 18
Mddd-07200610	20	DBR-0055-02000-ENC	5 x 14 x 13	DBR-0055-02000-ENC	5 x 14 x 13	DBR-0055-04500-ENC	5 x 28 x 13	DBR-0055-09000-ENC	7 x 29 x 18
Mddd-07200750	25	DBR-0055-02000-ENC	5 x 14 x 13	DBR-0055-03000-ENC	5 x 21 x 13	DBR-0055-06000-ENC	7 x 29 x 18	DBR-0055-09000-ENC	7 x 29 x 18
Mddd-07200830	30	DBR-0055-02000-ENC	5 x 14 x 13	DBR-0055-03000-ENC	5 x 21 x 13	DBR-0055-06000-ENC	7 x 29 x 18	DBR-0055-06000-ENC	14 x 29 x 18
Mddd-08201160	40	DBR-0055-02000-ENC	5 x 14 x 13	DBR-0055-03000-ENC	5 x 21 x 13	DBR-0055-09000-ENC	7 x 29 x 18	DBR-0055-18000-ENC	14 x 29 x 18
Mddd-08201320	50	DBR-0055-02000-ENC	5 x 14 x 13	DBR-0055-04500-ENC	5 x 28 x 13	DBR-0055-12000-ENC	14 x 29 x 18	DBR-0055-18000-ENC	14 x 29 x 18

aaa = Unidrive M100, M101, M200, M201, M300 & M400

bbb = Unidrive M600, M700, M701, M702, HS70, HS71, HS72

ccc = Unidrive M200, M201, M300, M400, M600, M700, M701, M702, HS70, HS71, HS72

ddd = Unidrive M400, M600, M700, M701, M702, HS70, HS71, HS72

Example: DBR-0400-00500-ENC is a 40.0 Ohm 500 W Resistor, E = NEMA 1 Enclosure and NC = Normally Closed Thermostat
Standard resistor assemblies are not U.L. recognized. Consult factory for U.L. versions.

Dynamic Braking Resistors

Dynamic Braking Resistors - 460 Vac

Galvanized NEMA 1 Enclosed

Drives	Heavy Duty HP	E-Stop Duty - NEMA 1 Normally Closed Thermostat		10% Duty Rated Normally Closed Thermostat		25% Duty Rated Normally Closed Thermostat		50% Duty Rated Normally Closed Thermostat	
		Order Code	Dims. (in) H x W x D	Order Code	Dims. (in) H x W x D	Order Code	Dims. (in) H x W x D	Order Code	Dims. (in) H x W x D
Maaa-02400013	0.5	DBR-3000-00300-ENC	5 x 14 x 4	DBR-3000-00300-ENC	5 x 14 x 4	DBR-3000-00300-ENC	5 x 14 x 4	DBR-3000-00300-ENC	5 x 14 x 4
Maaa-02400018	0.75	DBR-3000-00300-ENC	5 x 14 x 4	DBR-3000-00300-ENC	5 x 14 x 4	DBR-3000-00300-ENC	5 x 14 x 4	DBR-3000-00300-ENC	5 x 14 x 4
Maaa-02400023	1	DBR-3000-00300-ENC	5 x 14 x 4	DBR-3000-00300-ENC	5 x 14 x 4	DBR-3000-00300-ENC	5 x 14 x 4	DBR-3000-00800-ENC	5 x 14 x 10
Maaa-02400032	1.5	DBR-3000-00300-ENC	5 x 14 x 4	DBR-3000-00300-ENC	5 x 14 x 4	DBR-3000-00300-ENC	5 x 14 x 4	DBR-3000-00800-ENC	5 x 14 x 10
Maaa-02400041	2	DBR-3000-00300-ENC	5 x 14 x 4	DBR-3000-00300-ENC	5 x 14 x 4	DBR-3000-00800-ENC	5 x 14 x 10	DBR-3000-00800-ENC	5 x 14 x 10
Maaa-03400056	3	DBR-1200-00300-ENC	5 x 14 x 4	DBR-1200-00300-ENC	5 x 14 x 4	DBR-1200-01500-ENC	5 x 14 x 13	DBR-1200-01500-ENC	5 x 14 x 13
Maaa-03400073	3	DBR-1200-00300-ENC	5 x 14 x 4	DBR-1200-00300-ENC	5 x 14 x 4	DBR-1200-01500-ENC	5 x 14 x 13	DBR-1200-01500-ENC	5 x 14 x 13
Maaa-03400094	5	DBR-1200-00800-ENC	5 x 14 x 7	DBR-1200-00800-ENC	5 x 14 x 7	DBR-1200-01500-ENC	5 x 14 x 13	DBR-1200-03000-ENC	5 x 13 x 21.1
Maaa-04400135	7.5	DBR-0600-00400-ENC	5 x 14 x 4	DBR-0600-01000-ENC	5 x 14 x 10	DBR-0600-01500-ENC	5 x 14 x 13	DBR-0600-03000-ENC	5 x 28 x 13
Maaa-04400170	10	DBR-0600-00400-ENC	5 x 14 x 4	DBR-0600-01000-ENC	5 x 14 x 10	DBR-0600-03000-ENC	5 x 28 x 13	DBR-0600-04500-ENC	7 x 29 x 18
Mbbb-03400025	1	DBR-0800-00300-ENC	5 x 14 x 4	DBR-0800-00300-ENC	5 x 14 x 4	DBR-0800-00600-ENC	5 x 14 x 7	DBR-0800-00600-ENC	5 x 14 x 7
Mbbb-03400031	1.5	DBR-0800-00300-ENC	5 x 14 x 4	DBR-0800-00300-ENC	5 x 14 x 4	DBR-0800-00600-ENC	5 x 14 x 7	DBR-0800-00600-ENC	5 x 14 x 7
Mbbb-03400045	2	DBR-0800-00300-ENC	5 x 14 x 4	DBR-0800-00300-ENC	5 x 14 x 4	DBR-0800-00600-ENC	5 x 14 x 7	DBR-0800-01500-ENC	5 x 14 x 13
Mbbb-03400062	3	DBR-0800-00300-ENC	5 x 14 x 4	DBR-0800-00300-ENC	5 x 14 x 4	DBR-0800-01500-ENC	5 x 14 x 13	DBR-0800-01500-ENC	5 x 14 x 13
Mbbb-03400078	5	DBR-0600-00400-ENC	5 x 14 x 4	DBR-0600-00600-ENC	5 x 14 x 7	DBR-0600-01500-ENC	5 x 14 x 13	DBR-0600-01500-ENC	5 x 14 x 13
Mbbb-03400100	5	DBR-0600-00400-ENC	5 x 14 x 4	DBR-0600-00600-ENC	5 x 14 x 7	DBR-0600-01500-ENC	5 x 14 x 13	DBR-0600-03000-ENC	5 x 28 x 13
Mbbb-04400150	10	DBR-0400-00500-ENC	5 x 14 x 7	DBR-0400-01000-ENC	5 x 14 x 10	DBR-0400-01500-ENC	5 x 14 x 13	DBR-0400-03000-ENC	5 x 21 x 13
Mbbb-04400172	10	DBR-0400-00500-ENC	5 x 14 x 7	DBR-0400-01000-ENC	5 x 14 x 10	DBR-0400-03000-ENC	5 x 21 x 13	DBR-0400-04500-ENC	5 x 28 x 13
Mccc-05400270	20	DBR-0400-01000-ENC	5 x 14 x 10	DBR-0400-01500-ENC	5 x 14 x 13	DBR-0400-03000-ENC	5 x 21 x 13	DBR-0400-06000-ENC	9 x 28 x 18
Mccc-05400300	20	DBR-0200-01500-ENC	5 x 14 x 13	DBR-0200-01500-ENC	5 x 14 x 13	DBR-0200-04500-ENC	7 x 29 x 18	DBR-0200-09000-ENC	7 x 29 x 18
Mccc-06400350	25	DBR-0200-01500-ENC	5 x 14 x 13	DBR-0200-01500-ENC	5 x 14 x 13	DBR-0200-04500-ENC	7 x 29 x 18	DBR-0200-09000-ENC	7 x 29 x 18
Mccc-06400420	30	DBR-0200-01500-ENC	5 x 14 x 13	DBR-0200-03000-ENC	5 x 28 x 13	DBR-0200-06000-ENC	7 x 29 x 18	DBR-0200-09000-ENC	7 x 29 x 18
Mccc-06400470	30	DBR-0200-01500-ENC	5 x 14 x 13	DBR-0200-03000-ENC	5 x 28 x 13	DBR-0200-06000-ENC	7 x 29 x 18	DBR-0200-12000-ENC	14 x 29 x 18
Mddd-07400660	50	DBR-0120-03000-ENC	5 x 21 x 13	DBR-0120-03000-ENC	5 x 21 x 13	DBR-0120-09000-ENC	7 x 29 x 18	DBR-0120-18000-ENC	14 x 29 x 18
Mddd-07400770	60	DBR-0120-03000-ENC	5 x 21 x 13	DBR-0120-04500-ENC	5 x 28 x 13	DBR-0120-12000-ENC	14 x 29 x 18	DBR-0120-18000-ENC	14 x 29 x 18
Mddd-07401000	75	DBR-0100-03000-ENC	5 x 21 x 13	DBR-0100-06000-ENC	7 x 29 x 18	DBR-0100-12000-ENC	14 x 29 x 18	DBR-0100-24000-ENC	14 x 29 x 18
Mddd-08401340	100	DBR-0100-04500-ENC	5 x 28 x 13	DBR-0100-06000-ENC	7 x 29 x 18	DBR-0100-18000-ENC	14 x 29 x 18	DBR-0100-36000-ENC	21 x 29 x 18
Mddd-08401570	125	DBR-0100-06000-ENC	7 x 29 x 18	DBR-0100-09000-ENC	7 x 29 x 18	DBR-0100-24000-ENC	14 x 29 x 18	DBR-0100-36000-ENC	21 x 29 x 18
Mddd-09402000	150	DBR-0055-06000-ENC	7 x 29 x 18	DBR-0055-12000-ENC	14 x 29 x 18	DBR-0055-24000-ENC	14 x 29 x 18	DBR-0055-50000-ENC	28 x 29 x 18
Mddd-09402240	150	DBR-0055-09000-ENC	7 x 29 x 18	DBR-0055-12000-ENC	14 x 29 x 18	DBR-0055-36000-ENC	21 x 29 x 18	DBR-0055-60000-ENC	35 x 29 x 18
Mbbb-10402700	200	DBR-0055-12000-ENC	14 x 29 x 18	DBR-0055-18000-ENC	14 x 29 x 18				
Mbbb-10403240	250	DBR-0055-12000-ENC	14 x 29 x 18	DBR-0055-24000-ENC	14 x 29 x 18				

aaa = Unidrive M100, M101, M200, M201, M300 & M400

bbb = Unidrive M600, M700, M701, M702, HS70, HS71, HS72

ccc = Unidrive M200, M201, M300, M400, M600, M700, M701, M702, HS70, HS71, HS72

ddd = Unidrive M400, M600, M700, M701, M702, HS70, HS71, HS72

Example: DBR-0400-00500-ENC is a 40.0 Ohm 500 W Resistor, E = NEMA 1 Enclosure and NC = Normally Closed Thermostat

Standard resistor assemblies are not U.L. recognized. Consult factory for U.L. versions.



Dynamic Braking Resistors

Dynamic Braking Resistors - 575 Vac

Galvanized NEMA 1 Enclosed

Drives	Heavy Duty HP	E-Stop Duty - NEMA 1 Normally Closed Thermostat		10% Duty Rated Normally Closed Thermostat		25% Duty Rated Normally Closed Thermostat		50% Duty Rated Normally Closed Thermostat	
		Order Code	Dims. (in) H x W x D	Order Code	Dims. (in) H x W x D	Order Code	Dims. (in) H x W x D	Order Code	Dims. (in) H x W x D
Mccc-05500030	2	DBR-1200-00300-ENC	5 x 14 x 4	DBR-1200-00300-ENC	5 x 14 x 4	DBR-1200-00800-ENC	5 x 14 x 7	DBR-1200-00800-ENC	5 x 14 x 7
Mccc-05500040	3	DBR-1200-00300-ENC	5 x 14 x 4	DBR-1200-00300-ENC	5 x 14 x 4	DBR-1200-00800-ENC	5 x 14 x 7	DBR-1200-01500-ENC	5 x 14 x 13
Mccc-05500069	5	DBR-1200-00300-ENC	5 x 14 x 4	DBR-1200-00800-ENC	5 x 14 x 7	DBR-1200-01500-ENC	5 x 14 x 13	DBR-1200-01500-ENC	5 x 14 x 13
Mccc-06500100	7.5	DBR-0800-00300-ENC	5 x 14 x 4	DBR-0800-00600-ENC	5 x 14 x 7	DBR-0800-01500-ENC	5 x 14 x 13	DBR-0600-03000-ENC	5 x 28 x 13
Mccc-06500150	10	DBR-0600-00400-ENC	5 x 14 x 4	DBR-0600-01500-ENC	5 x 14 x 13	DBR-0600-03000-ENC	5 x 28 x 13	DBR-0400-04500-ENC	5 x 28 x 13
Mccc-06500190	15	DBR-0400-00500-ENC	5 x 14 x 7	DBR-0400-01500-ENC	5 x 14 x 13	DBR-0400-03000-ENC	5 x 21 x 13	DBR-0400-06000-ENC	9 x 28 x 18
Mccc-06500230	20	DBR-0200-01500-ENC	5 x 14 x 13	DBR-0200-01500-ENC	5 x 14 x 13	DBR-0200-04500-ENC	7 x 29 x 18	DBR-0200-09000-ENC	7 x 29 x 18
Mccc-06500290	25	DBR-0200-01500-ENC	5 x 14 x 13	DBR-0200-03000-ENC	5 x 28 x 13	DBR-0200-04500-ENC	7 x 29 x 18	DBR-0200-09000-ENC	7 x 29 x 18
Mccc-06500350	30	DBR-0150-01500-ENC	5 x 14 x 13	DBR-0150-03000-ENC	5 x 21 x 13	DBR-0150-06000-ENC	7 x 29 x 18	DBR-0150-12000-ENC	14 x 29 x 18
Mddd-07500440	40	DBR-0150-01500-ENC	5 x 14 x 13	DBR-0150-03000-ENC	5 x 21 x 13	DBR-0150-06000-ENC	7 x 29 x 18	DBR-0150-12000-ENC	14 x 29 x 18
Mddd-07500550	50	DBR-0150-03000-ENC	5 x 21 x 13	DBR-0150-03000-ENC	5 x 21 x 13	DBR-0150-09000-ENC	7 x 29 x 18	DBR-0150-18000-ENC	14 x 29 x 18
Mddd-08500630	60	DBR-0150-03000-ENC	5 x 21 x 13	DBR-0150-04500-ENC	5 x 28 x 13	DBR-0150-12000-ENC	14 x 29 x 18	DBR-0150-18000-ENC	14 x 29 x 18
Mddd-08500860	75	DBR-0150-03000-ENC	5 x 21 x 13	DBR-0150-06000-ENC	7 x 29 x 18	DBR-0150-12000-ENC	14 x 29 x 18	DBR-0150-24000-ENC	21 x 29 x 18

ccc = Unidrive M200, M201, M300, M400, M600, M700, M701, M702, HS70, HS71, HS72

ddd = Unidrive M400, M600, M700, M701, M702, HS70, HS71, HS72

Example: DBR-0200-00600-ENC is a 20.0 Ohm 600 W Resistor, E = NEMA 1 Enclosure and NC = Normally Closed Thermostat

Standard resistor assemblies are not U.L. recognized. Consult factory for U.L. versions.



Hardware Options

Heatsink Mount DB Resistors

Description	Order Code	Product Compatibility				
		M200-300	M400	M600	M700	HS70
M600-700 Frame 3 Heatsink Mount DB Resistor, 75OHM, 50W	UM-HEATSINK-F3			Y	Y	Y
M200-700 Frame 4 and 5 Heatsink Mount DB Resistor, 37.5 OHM, 100W	UM-HEATSINK-F4-5	Y*	Y*	Y	Y	Y

*Frame 5 only

NEMA 1 Conduit Kits

Description	Order Code	Product Compatibility				
		M100	M200-300	M400	M600-700	HS70
NEMA 1 Conduit Kit for Unidrive M100-400 - Size 1	C-BOX-OF1	Y	Y	Y		
NEMA 1 Conduit Kit for Unidrive M100-400 - Size 2	C-BOX-OF2	Y	Y	Y		
NEMA 1 Conduit Kit for Unidrive M100-400 - Size 3	C-BOX-OF3	Y	Y	Y		
NEMA 1 Conduit Kit for Unidrive M100-400 - Size 4	C-BOX-OF4	Y	Y	Y		
NEMA 1 Conduit Kit for Unidrive M600-700, HS70 - Size 3 and 4	C-BOX-GF3-4				Y	Y
NEMA 1 Conduit Kit for Unidrive M - Size 5	C-BOX-F5		Y	Y	Y	Y
NEMA 1 Conduit Kit for Unidrive M - Size 6	C-BOX-F6		Y	Y	Y	Y
NEMA 1 Conduit Kit for Unidrive M - Size 7	C-BOX-F7			Y	Y	Y
NEMA 1 Conduit Kit for Unidrive M - Size 8	C-BOX-F8			Y	Y	Y
NEMA 1 Conduit Kit for Unidrive M - Size 9 & 10	C-BOX-F9-10			Y*	Y	Y

*Frame 9 only

Through Hole Panel Mount Kits

Description	Order Code	Product Compatibility			
		M200-300	M400	M600-700	HS70
Through Hole Mount Kit for Unidrive M600-700, HS70 - Size 3	THM-KIT-F3			Y	Y
Through Hole Mount Kit Multi Axis for Unidrive M600-700, HS70 - Size 3	THM-KIT-F3M			Y	Y
Through Hole Mount Kit for Unidrive M600-700, HS70 - Size 4	THM-KIT-F4			Y	Y
Through Hole Mount Kit for Unidrive M - Size 5	THM-KIT-F5	Y	Y	Y	Y
Through Hole Mount Kit for Unidrive M - Size 6	THM-KIT-F6	Y	Y	Y	Y
Through Hole Mount Kit for Unidrive M - Size 7	THM-KIT-F7		Y	Y	Y
Through Hole Mount Kit for Unidrive M - Size 8	THM-KIT-F8		Y	Y	Y
Through Hole Mount Kit for Unidrive M - Size 9-10E	THM-KIT-F9E-F10E		Y*	Y	Y
Through Hole Mount Kit for Unidrive M Modular Rectifier- Size 9-10	THM-KIT-F9R-F10R			Y	Y
Through Hole Mount Kit for Unidrive M Modular Inverter- Size 9-10D	THM-KIT-F9D-F10D			Y	Y

*Frame 9 only

Tile Mount Kits (Order Keypad Separately)

Description	Order Code	Product Compatibility		
		M200-400	M600-700	HS70
Tile Mount Kit for Unidrive M600-700, HS70 - Size 3	TILEM-KIT-F3		Y	Y
Tile Mount Kit for Unidrive M600-700, HS70 - Size 4	TILEM-KIT-F4		Y	Y
Tile Mount Kit for Unidrive M - Size 5	TILEM-KIT-F5	Y	Y	Y

DC Paralleling Kits

Description	Order Code	Product Compatibility		
		M200-400	M600-700	HS70
DC Paralleling Kit Unidrive M600-700, HS70 Frame 3	DCP-KIT-F3		Y	Y
DC Paralleling Kit Unidrive M600-700, HS70 Frame 4	DCP-KIT-F4		Y	Y
DC Paralleling Kit Unidrive M Frame 5	DCP-KIT-F5	Y	Y	Y
DC Paralleling Kit Unidrive M Frame 6	DCP-KIT-F6	Y	Y	Y
DC Paralleling Kit Unidrive M Frame 6 to frames 3, 4 & 5	DCP-KIT-F6-TO-F3-5		Y	Y

Hardware Options

Retrofit Kits for Unidrive M

Description	Order Code	Product Compatibility				
		M100	M200-300	M400	M600-700	HS70
Frame 3 Retrofit Panel Mounting Kit for Unidrive M100-400	3470-0097	Y	Y	Y		
Frame 4 Retrofit Panel Mounting Kit for Unidrive M100-400	3470-0101	Y	Y	Y		
Frame 4 Retrofit Panel Mounting Kit for Unidrive M600-700, HS70	3470-0062				Y	Y
Frame 5 Retrofit Panel Mounting Kit	3470-0066		Y	Y	Y	Y
Frame 6 Retrofit Panel Mounting Kit	3470-0074		Y	Y	Y	Y
Frame 7 Retrofit Panel Mounting Kit	3470-0078			Y	Y	Y
Frame 8 Retrofit Panel Mounting Kit	3470-0087			Y	Y	Y
Frame 9 and 10D & E Retrofit Panel Mounting Kit	3470-0118			Y*	Y	Y

*Frame 9 only



EMERSON. CONSIDER IT SOLVED.™

www.emersonindustrial.com



SCIGATE AUTOMATION (S) PTE LTD

No.1 Bukit Batok Street 22 #01-01 Singapore 659592

Tel: (65) 6561 0488

Fax: (65) 6562 0588

Email: sales@scigate.com.sg

Web: www.scigate.com.sg

Business Hours: Monday - Friday 8.30am - 6.15pm



P/N BRO-UNIM-ACCESS 03/15

© Emerson 2015. The information contained in this brochure is for guidance only and does not form part of any contract. The accuracy cannot be guaranteed as Emerson have an ongoing process of development and reserve the right to change the specification of their products without notice.

Control Techniques Limited. Registered Office: The Gro, Newtown, Powys SY16 3BE. Registered in England and Wales. Company Reg. No. 01236886.

Moteurs Leroy-Somer SAS. Headquarters: Bd Marcellin Leroy, CS 10015, 16915 Angoulême Cedex 9, France. Share Capital: 65 800 512 €; RCS Angoulême 338 567 258.